

IQ PANEL 2 IQ PANEL 2+

INSTALLATION MANUAL

Qolsys IQ Panel 2/2+
Software Version 2.3.0

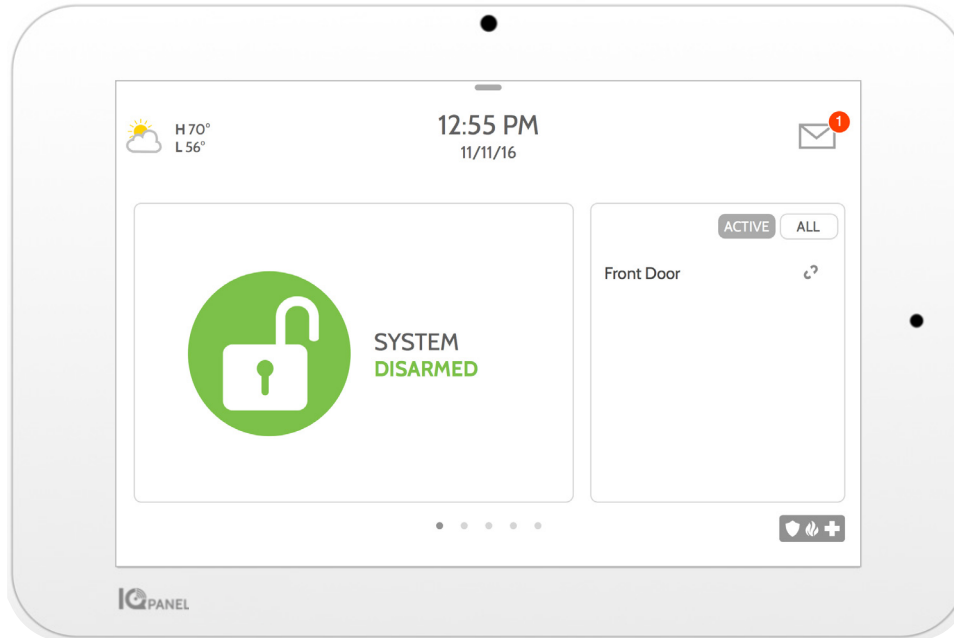

The Qolsys IQ Panel 2 & IQ Panel 2+ is a 7" touchscreen built with an Android operating system, providing full security and smart home functionality in an easy to use interface.

INCLUDED IN BOX

IQ Panel 2/2+

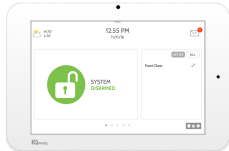

Power Supply

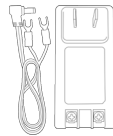
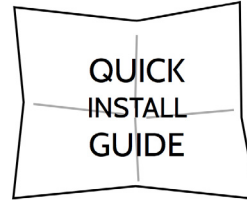
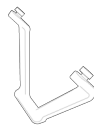

Table Stand



ABOUT THIS GUIDE

This document outlines the basic hardware specifications and software directions to install and customize the IQ Panel 2 & IQ Panel 2+. Note that the information presented is not comprehensive, but is specifically dedicated to those menus, features, and systems accessible solely to those with the proper installation code.

Features accessible to users and installers alike are outlined in the IQ Panel 2 User Guide. The information contained is confidential and proprietary, and is solely owned by Qolsys Inc. Any reproduction, modification or distribution without permission is strictly prohibited.

SUPPORT



QUESTIONS?

Contact us at
techsupport@qolsys.com

TABLE OF CONTENTS



PANEL OVERVIEW

- 5- Exterior Front
- 6- Exterior Back
- 7- Interior

INSTALLING THE PANEL

- 9- Wall Mount Option
- 10- Table Stand Option
- 11- Wiring Diagram
- 12- Powering the Panel

USER INTERFACE

- 14- Home Screen Overview
- 15- Message Center
- 16- Settings Tray

PROGRAMMING

- 18- Lock Screen
- 19- Settings
- 21- Advanced Settings
- 22- Setup Wizard
- 25- Installation
- 27- Installer/Dealer Settings
- 31- System Logs
- 32- Siren and Alarms
- 34- Security and Arming
- 37- Camera Settings
- 38- Z-Wave Device List
- 39- Sound
- 41- Partitions
- 42- Local Automation

SECURITY SENSORS

- 45- Security Sensors
- 46- Auto Learn Sensor
- 47- Add Sensor
- 48- Partitions
- 49- Sensor Type
- 50- Sensor Groups
- 64- Sensor Name
- 66- Chime Type
- 67- Voice Prompts
- 68- Source

WI-FI DEVICES

- 70- Wi-Fi Devices
- 72- Access Point Settings
- 73- AP Connected Devices
- 74- IQ Remote Devices

Z-WAVE DEVICES

- 76- Z-Wave Devices
- 77- Add Device
- 78- Clear Device
- 79- Delete Failed Device
- 80- Remove All Devices
- 81- View/Edit Associations
- 82- Z-Wave Settings

BLUETOOTH DEVICES

- 85- Bluetooth Devices
- 86- Add Device
- 87- Edit Device

- 88- Delete Device
- 89- Remove All Devices
- 90- Settings
- 91- Add Speaker

SYSTEM TESTS

- 93- System Tests
- 95- Wi-Fi Test
- 96- Sensor Test
- 100- Cellular Test
- 101- Image Sensor Config
- 102- Z-Wave Test
- 103- Rediscover Network
- 104- Neighbor Info
- 105- Counters
- 107- Z-Wave Diagnostics
- 108- Advanced Z-Wave Diag
- 109- PowerG Test
- 110- Panel Glass Break Test
- 113- Dual Path Test
- 114- Daughter Cards Test
- 115- Panel Test

CUSTOMIZATION

- 117- User Management
- 118- Dealer Branding
- 119- Contact Info
- 120- Load Custom Logo
- 121- On-Screen Billboard
- 122- Load Help Videos
- 123- Connecting to Wi-Fi

- 124- Weather
- 125- Photo Frame
- 128- Load Images from SD Card

MAINTENANCE

- 130- Upgrade Software
- 131- Upgrade Software Using Wi-Fi
- 132- Software Update Via SD Card
- 133- Automatic Software Updates
- 134- Battery Replacement

TROUBLESHOOTING

- 136- About
- 139- Power Down
- 140- Panel Reboot
- 141- Hard Reboot
- 142- Panel Test Troubleshooting
- 144- Cannot Load Help Videos

LEGAL

- 146- Important Information

SPECIFICATIONS

- 150- Specifications
- 152- Supported S-Line Sensors
- 153- Supported PowerG Sensors

PANEL OVERVIEW

Warning: This Product should be installed in accordance with the National Fire Alarm Code, ANSI/NFPA 72, (National Fire Protection Association, Batterymarch Park, Quincy, MA 02269). Printed information describing proper installation, operation, testing, maintenance, evacuation planning, and repair service is to be provided with this Product. In Canada the product shall be installed in accordance with the Standard for the Installation of Residential Fire Warning Systems, CAN/ULC-S540.

Warning: For Canadian installations this Product and all sensors associated with it (collectively, the "System") should be tested once a week. The test shall be performed also with primary DC power de-energized. For recommended smoke detectors maintenance instructions refer to user manual associated with compatible Qolsys model QS5110-P840 smoke detector.

EXTERIOR FRONT

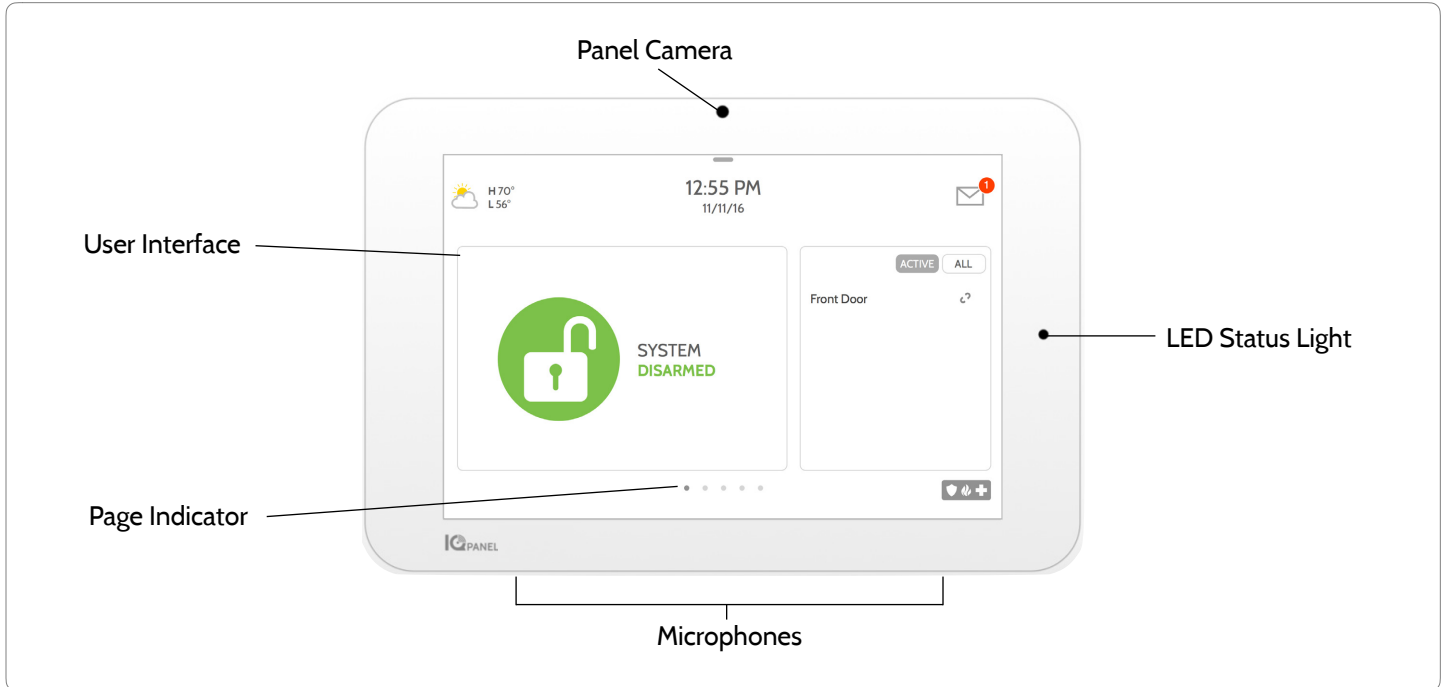

EXTERIOR BACK

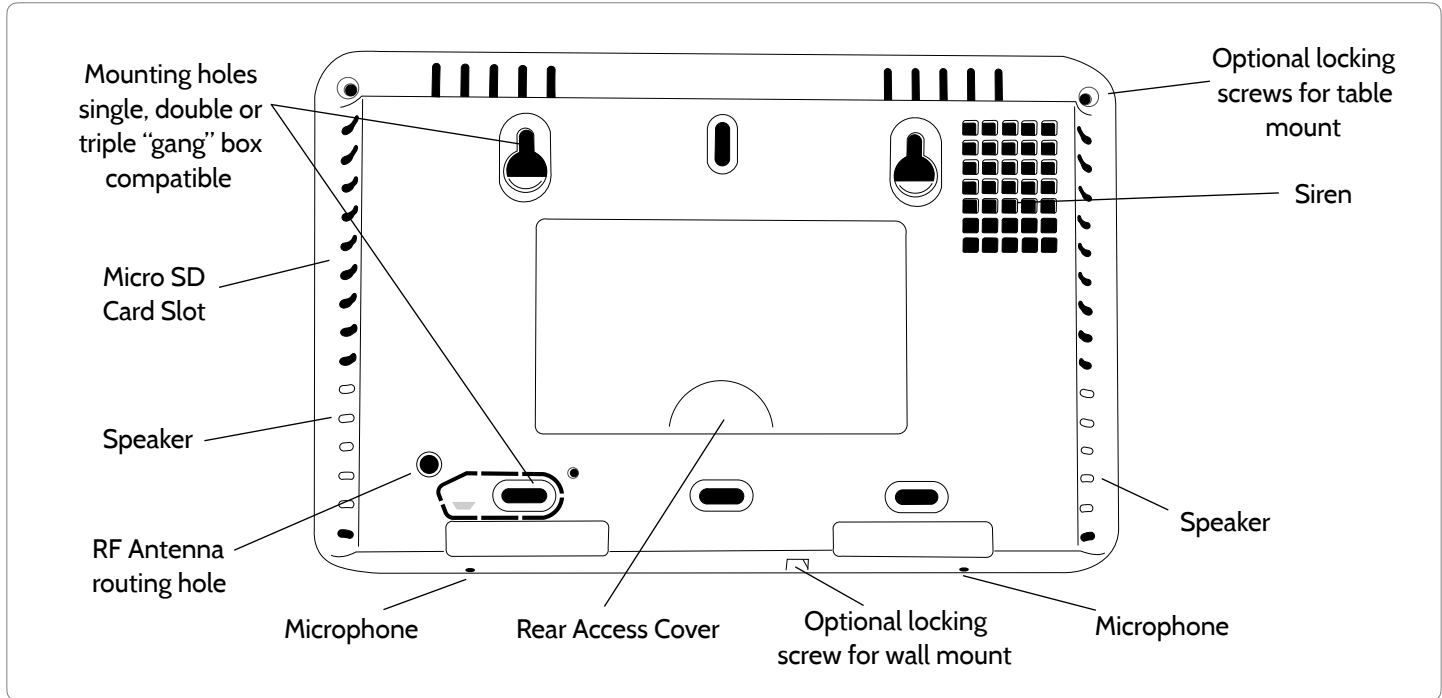

INTERIOR

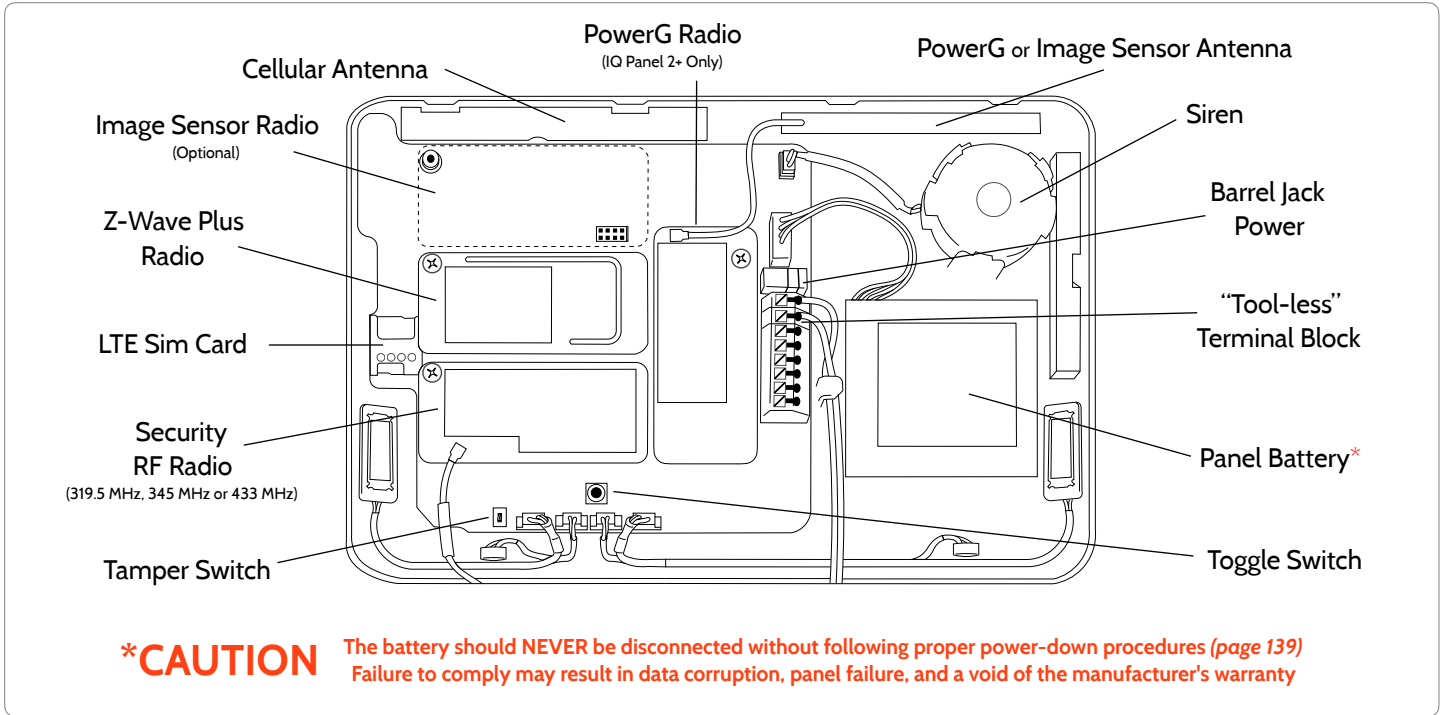

***CAUTION** The battery should NEVER be disconnected without following proper power-down procedures (page 139)
Failure to comply may result in data corruption, panel failure, and a void of the manufacturer's warranty

INSTALLING THE PANEL

INSTALLING THE PANEL



WALL MOUNT OPTION

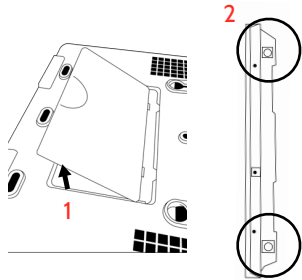

1. Insert your thumb or finger under the opening on the back cover and firmly pull up to remove. This cover is not needed for wall mount.
2. Press tabs on the bottom of the panel and pull apart to remove the back plate.

Mount to the wall using appropriate hardware ensuring it is level.

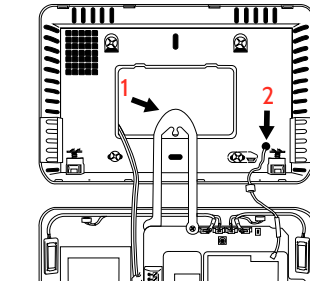

1. Hang the front of the panel with the hanging strap on the back plate as shown above.
2. Using the provided hole in the lower right hand side of the backplate as a template, drill a 1/4" hole in the wall and feed the white RF antenna into the wall.

IMPORTANT: Not properly routing the RF antenna in the wall will greatly reduce RF sensor range.

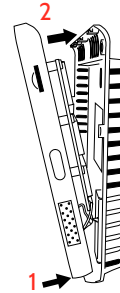

Connect the power supply to the barrel jack or to the (+/- Red) and (-/Black) terminals if using a custom length wire.

1. Latch the bottom of the panel into place, ensuring the the RF antenna and power wire are routed into the wall and not pinched.
2. Swing the panel up towards the 4 snap tabs at the top.

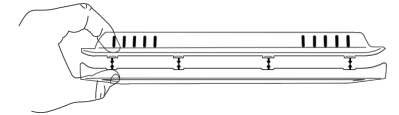

Firmly pinch "diagonally and down" from the top front of the bezel at all 4 snap tab locations to ensure proper closure. You will hear a "pop" or "snap" sound when each tab has closed properly and the gap along the top should be tightly seated.

IMPORTANT: Not properly closing the panel could result in damage to the backplate or false panel tamperers.

TABLE STAND OPTION

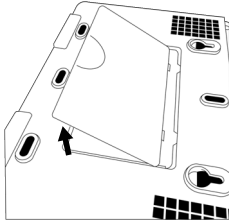

Insert your thumb or finger under the opening on the back cover and firmly pull up to remove.

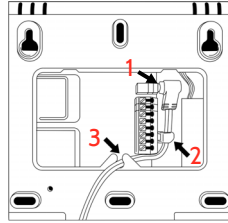

1. With the included power supply and cable, plug the barrel connector into the jack next to the terminals as shown above.
2. Route the cable under the hook next to the battery.
3. Route the cable through the strain relief opening.

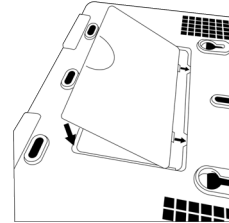

Replace the cover by inserting the top first, then while making sure the cable passes under the opening firmly press down on the bottom until the cover “snaps” into place.

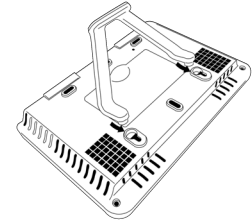

Insert table stand dowels into the 2 upper keyholes.

Slide the stand firmly upwards until you hear a “click” from each side.

WIRING DIAGRAM

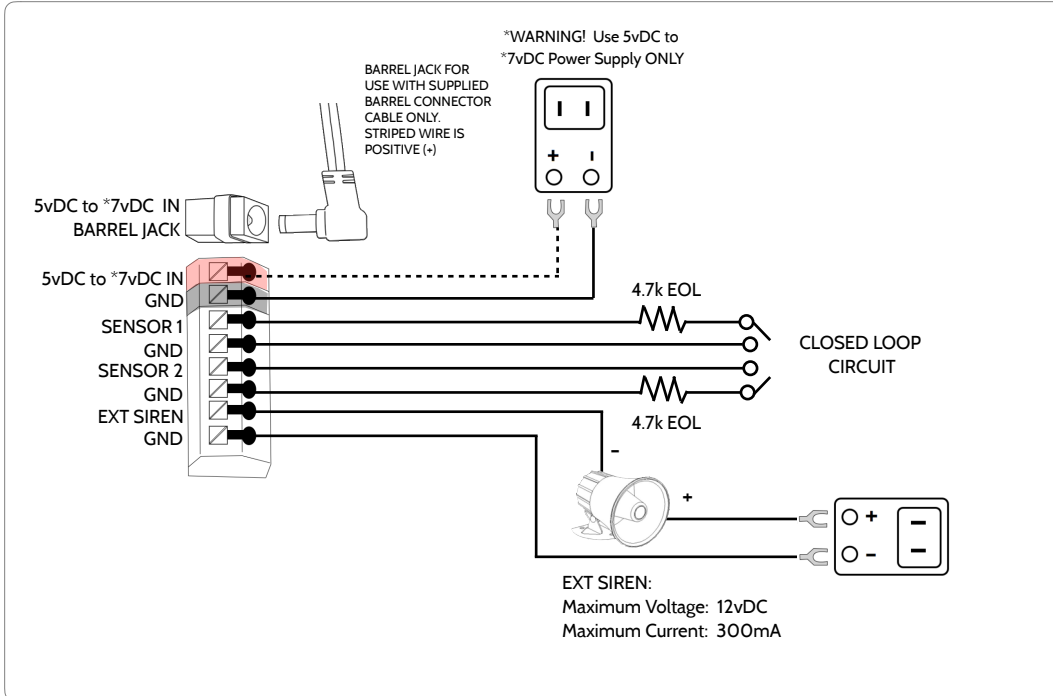

NOTES

IMPORTANT IF USING CUSTOM LENGTH WIRE:

- 5.5vDC Transformer: Use 18AWG wire no longer than 25ft to ensure sufficient power is received at the panel.

- 7vDC Transformer: Use 18AWG wire no longer than 100ft to ensure sufficient power is received at the panel.

* A 7vDC power supply is only supported on panels with hardware revision E or newer.

NOTE: Inputs are used only for Burglary applications.

NOTE: Use only UL/ cUL listed external siren in UL/cUL listed installations. Rating:12vDC/ 300mA

POWERING THE PANEL

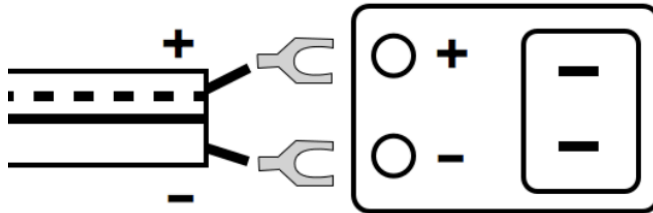

Connect power supply.

WARNING! Use a 5vDC to 7vDC Power Supply ONLY

If using the provided cable, the “striped” wire is (+)

Press and hold the power button on the right side of the panel for 3 seconds to power up.

USER INTERFACE

HOME SCREEN OVERVIEW

The home screen is divided into three sections. The header shows the date & time, today's weather, message center and the Settings tray. The Primary interface shows arming options and sensor status & partition select. The footer shows panic options and additional pages.

Header &
Settings Tray

Primary User
Interface &
Partition

Page
Indication and
Emergency

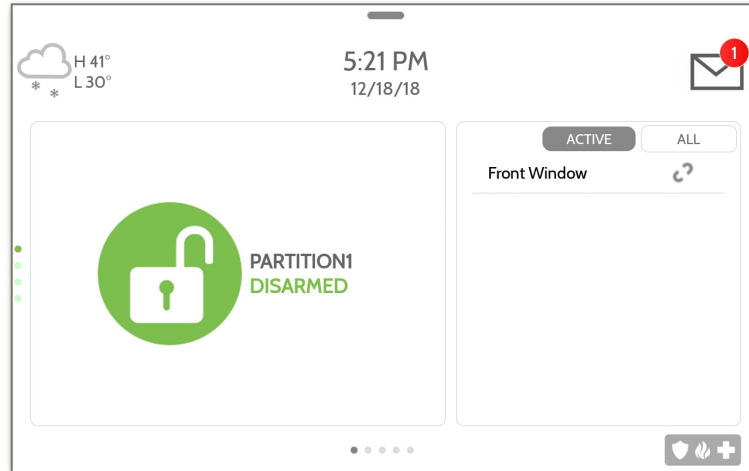

MESSAGE CENTER

The header contains the the pull down settings tray, the weather icon, time/date and a message icon in the upper right portion of the screen where you will find Security Provider messages and contact info, alerts, video tutorials and FAQ's



11:18 AM
09/15/16



CONTACT US

This is where you will find the Security Provider's Contact Information

VIDEO TUTORIALS

This is where you will find Video Tutorials to help with common questions

MESSAGES/ALERTS/ALARMS 8

This is where you will find messages from the Security Provider, Panel Alerts and Alarm Notifications.

SETTINGS TRAY

To access the Settings tray swipe down on the bar at the top of the screen. The Settings tray has quick access to system, battery, Wi-Fi, bluetooth & cellular status as well as volume control, brightness, a lock screen icon and other quick settings.

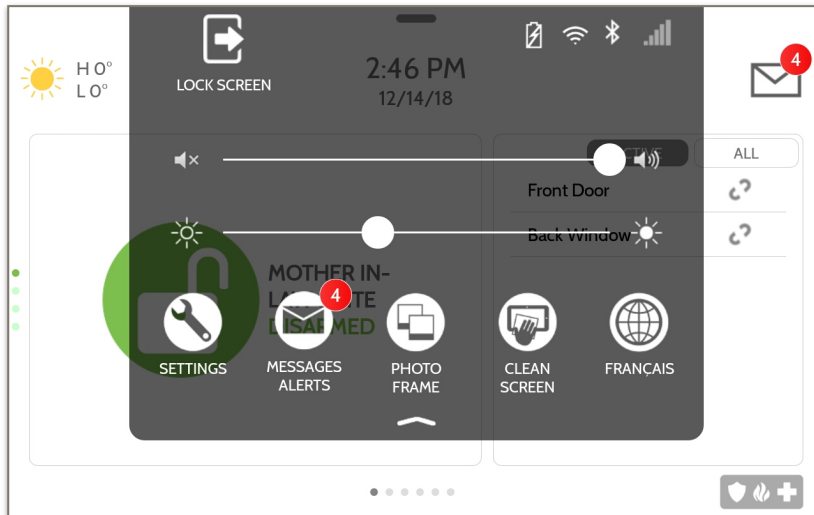

FIND IT

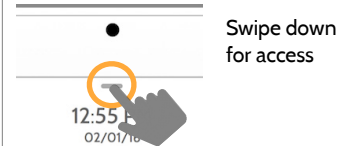

When partitions are **ENABLED**, a Lock Screen icon replaces the Status icon. Touch this icon to switch between partitions.



When partitions are **DISABLED**, a Status icon resides in the upper left corner of the settings tray. Touch this icon to return to the security page.

PROGRAMMING

LOCK SCREEN

When partitions are enabled a lock screen will be presented once the panel has been woken from either a touch on the screen or pressing the wake/sleep button on the side of the panel. This prevents one partition from accessing another as well as managing permissions to “Advanced Settings”:

4 DIGIT SCREEN LOCK

1	2	3
4	5	6
7	8	9
CLEAR	0	⬅️ X

TO ACCESS THIS AREA PLEASE ENTER YOUR CODE

○ ○ ○ ○

6 DIGIT SCREEN LOCK

1	2	3
4	5	6
7	8	9
CLEAR	0	⬅️ X

TO ACCESS THIS AREA PLEASE ENTER YOUR CODE

○ ○ ○ ○ ○ ○

SETTINGS

FIND IT

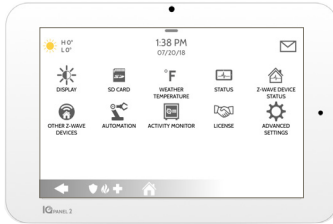

The Settings page allows quick access to various simple features & settings that do not require the protection of a Dealer, Installer or Master code to be changed.

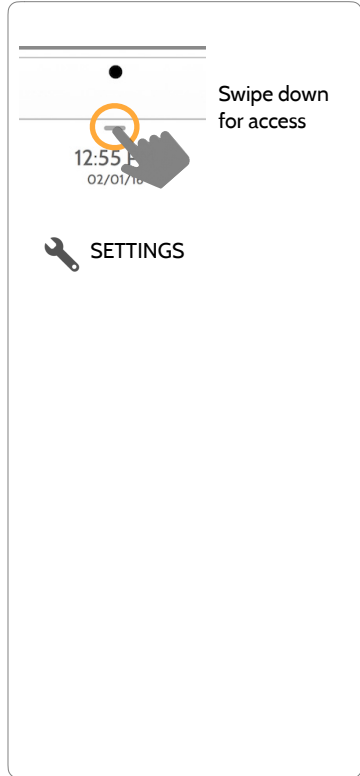

Setting	Description
Display	Adjust brightness, font size & 12/24 hour time
SD Card	Mount, unmount and manage SD Cards that are installed in a panel
Weather Temperature	Toggle between Farenheight and Celcius
Status	View the "Current Status" of security sensors: Zone #, Name, Status (Open, Close, Active, Idle, Tamper, Failure), Battery and sensor History. Also view "Alarms" and "History" for security sensors globally
Z-Wave Device Status	View the "Current Status" of Z-Wave devices: Name, Type, Status (Normal, Failure), and Battery. Also view "Alerts" and "History" for Z-Wave globally
Other Z-Wave Devices	Shows Z-Wave devices that are learned into the panel but that are not part of the main user interface (Lights, Locks, Thermostats & Garage Doors)

SETTINGS

Setting	Description
Automation	<p>Add, Edit or manage local lighting automation rules. These rules are separate from any cloud based rules that may be set through Alarm.com. Examples of possible rules are as follows:</p> <ul style="list-style-type: none"> - Night: Turns light on at 7pm and off at 6am - Evening: Turns light on at 7pm and off at 11pm - Front Door: Turns light on for 15mins when Front Door opens between 5pm and 7am (must have a sensor with the default quick name "Front Door" added in the panel) - Doorbell: Turns light on between 5pm and 7am for 15 mins when Doorbell is activated (must have a sensor with the default quick name "Doorbell" added in the panel)
License	Qolsys End User License Agreement
Activity Monitor	<p>Activity Monitor allows access to disarm sensors that are programmed as 24 hours zones, such as Sensor Groups 8, 9 & 25. A valid Master, User or Guest code is required to control 24 hour activity sensors. 2 options are provided:</p> <ul style="list-style-type: none"> - Quick Access: 300 second temporary access - Deactivate: Disarms 24 hour sensors until they are re-activated manually
Advanced Settings	Access advanced settings & programming. A valid Dealer (default 2222), Installer (default 1111) or Master Code (default 1234) is required

FIND IT

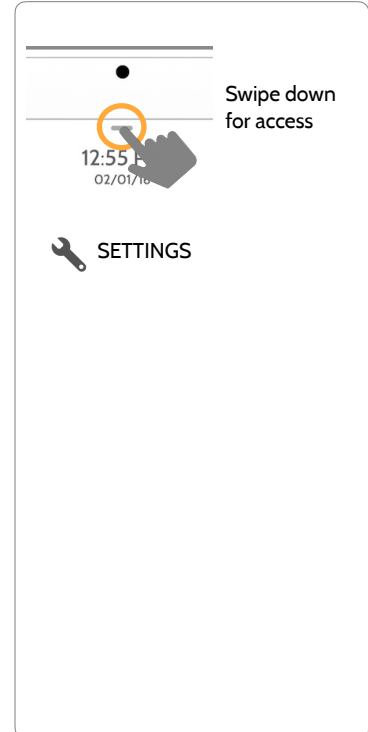

ADVANCED SETTINGS

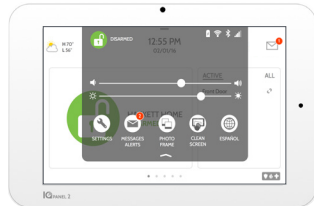

To access the Advanced Settings menu pull down the Settings tray at the top of the screen, select “Settings” and then “Advanced Settings”. Enter your dealer, installer or master code. The code used to enter Advanced Settings determines the level of access. When using partitions the code entered at the screen lock determines the access level for Advanced Settings.

INSTALLER MENU (1111)

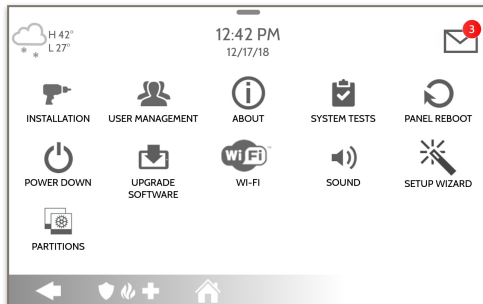

DEALER MENU (2222)

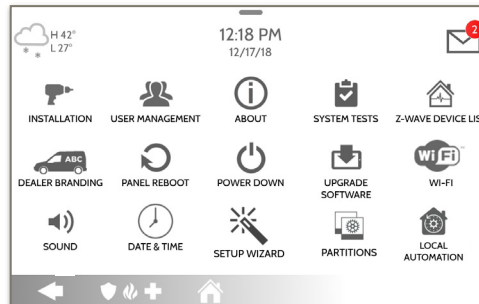

FIND IT

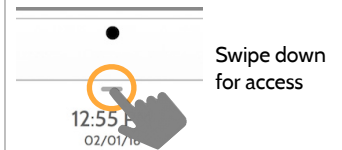

* The “Partitions” icon will only appear if Partitions are enabled under Installer/Dealer Settings

SETUP WIZARD



Setup Wizard

The “Easy Install Wizard” is an onscreen, step-by-step programming tool that makes the already fast and intuitive installation process even easier, ensuring every install is consistent and follows best practices.



Launch Wizard

Selecting Launch Wizard will initiate the Easy Setup Wizard based on the page configuration chosen.



Wizard Settings

Choose which pages you want to be shown during the Wizard walkthrough. Select Advanced or Simple sensor setup.

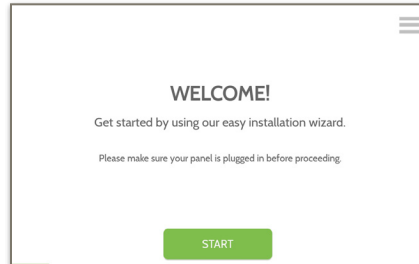

FIND IT

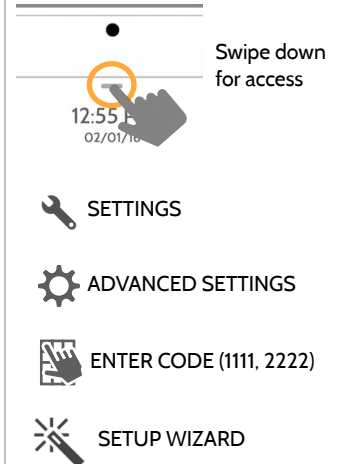

LAUNCH WIZARD



Launch Wizard

Selecting Launch Wizard will initiate the Easy Setup Wizard based on the page configuration chosen in Wizard Settings. Available pages are: Welcome, Wi-Fi, System Check, Update, Security, Panel Glass Break, Z-Wave, Bluetooth, Users & Dealer.

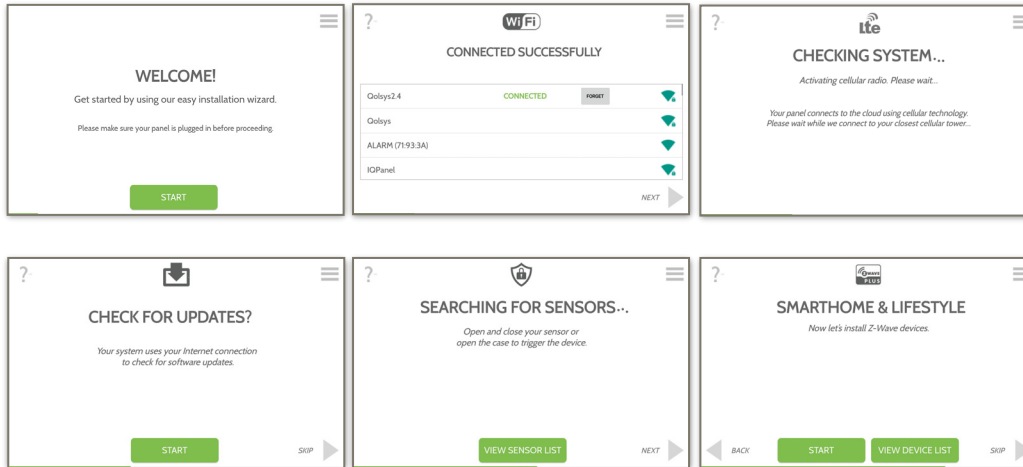

FIND IT

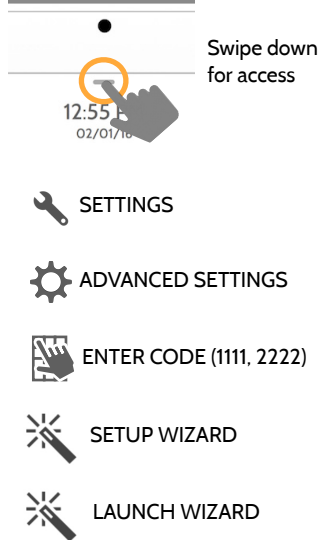

WIZARD SETTINGS



Wizard Settings

Choose which pages you want to be shown during the Wizard walkthrough.
Select Advanced or Simple sensor setup

Setting	Default	Description
Update	Enabled	Show the option to check for software updates in the Setup Wizard
Security	Enabled	Show the option to add and edit security sensors in the Setup Wizard
Security Sensor Setup Format	Advanced	Determines whether the Security page of the Setup Wizard shows Advanced Sensor pairing (PRO) or Simple Sensor pairing (DIY)
Panel Glass Break	Enabled	Show the option to enable or disable the panel glass break in the Setup Wizard
Z-Wave	Enabled	Show the option to include and edit Z-Wave devices in the Setup Wizard
Bluetooth	Enabled	Show the option to pair Bluetooth devices in the Setup Wizard
Users	Enabled	Show the option to add users in the Setup Wizard
Dealer	Enabled	Show the option to add and edit Dealer Contact Info in the Setup Wizard

FIND IT

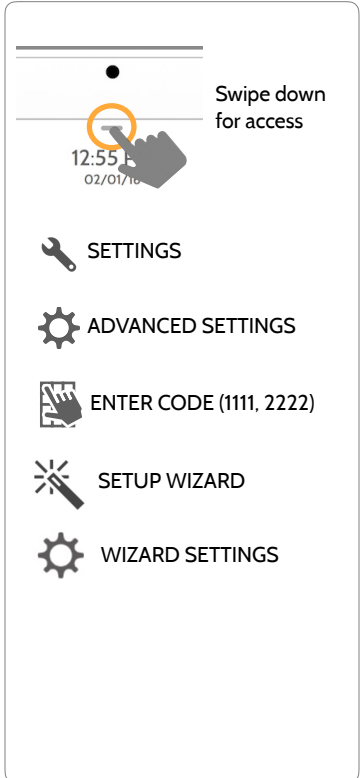

Swipe down for access

- SETTINGS
- ADVANCED SETTINGS
- ENTER CODE (1111, 2222)
- SETUP WIZARD
- WIZARD SETTINGS

INSTALLATION

If Dealer Contact info is not previously filled out or pushed from Alarm.com, a pop up is generated when accessing the “Installation” icon, requiring that dealer contact information to be entered. This information is used to populate the “Contact Us” tab in the Message Center. *Note: Company Name and Company Phone Number are required and must be filled out to continue with panel programming.*

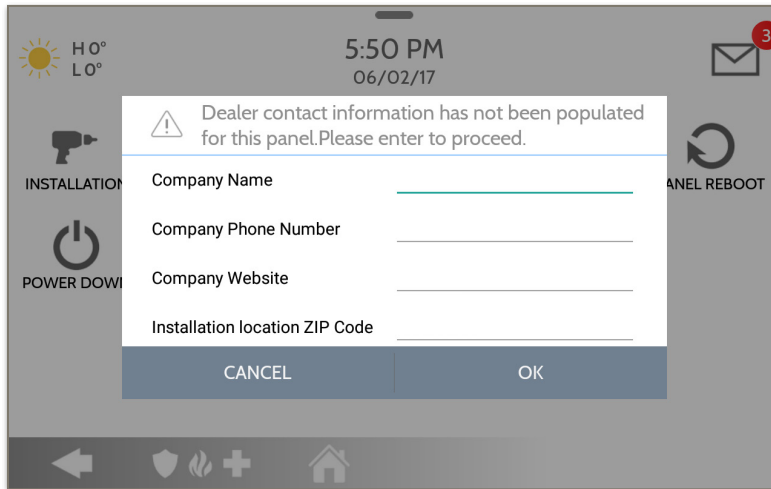

FIND IT

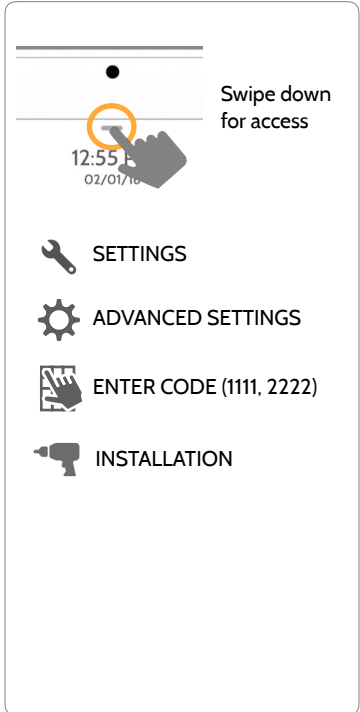

INSTALLATION

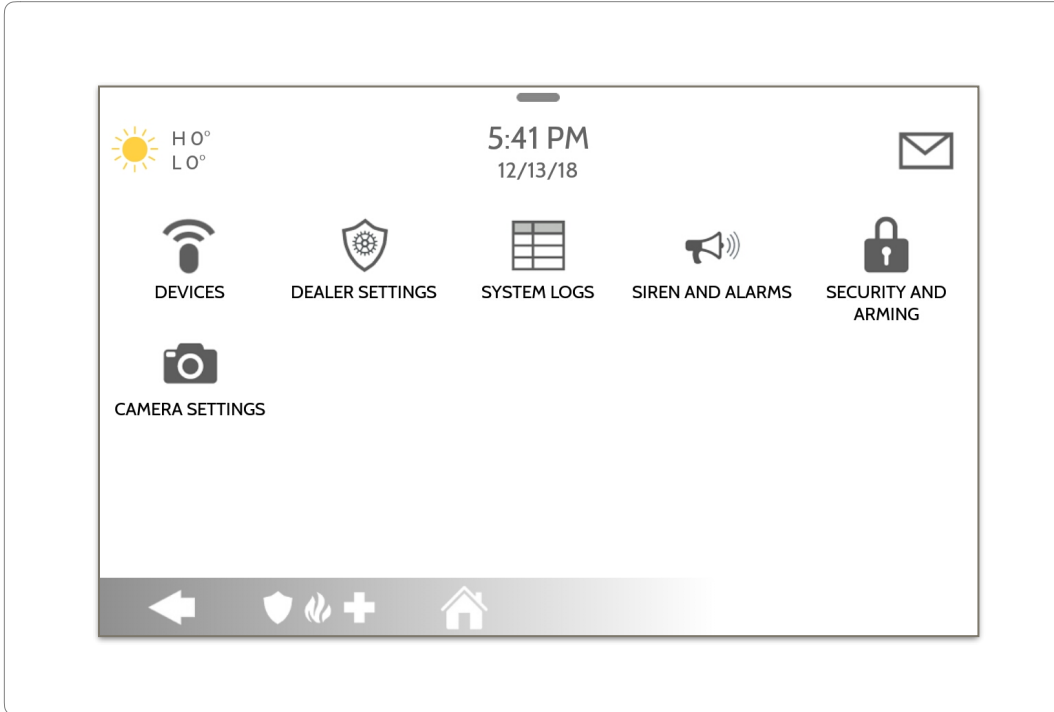

FIND IT

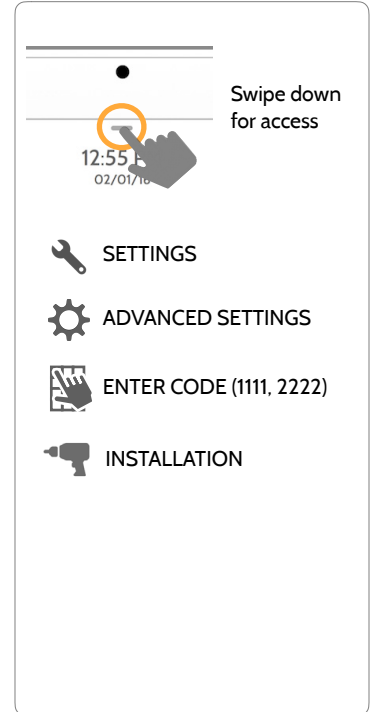

INSTALLER/DEALER SETTINGS



Installer/Dealer Settings

Change panel settings like supervisory times, power and cell loss timeout and SIA settings.

Setting	Default	Description
Account Number	blank	Security provider account number (up to 10 characters)
Power Management	Enabled	An energy-saving function when running on battery power only
SIA Power Restoration	Disabled	Turn on or off sensor hold for 60 seconds during power restore
Loss of Supervisory Signals for Emergency Sensors	4	Select the length in hours (4,12,24) before reporting a loss of supervision on life safety devices. NOTE: For UL/cUL the wireless supervision window for Emergency sensors (Smoke, Heat & CO Detectors) shall be set to 4h
Loss of Supervisory Signals for Z-Wave	4	Select the length in hours (4/24hrs) before reporting a loss of supervision on Z-Wave Sirens.
Loss of Supervisory Signals for Non Emergency Sensors	24	Select the length in hours (4,12,24) before reporting a loss of supervision on security devices

FIND IT



SETTINGS



ADVANCED SETTINGS



ENTER CODE (1111, 2222)



INSTALLATION



INSTALLER/DEALER SETTINGS

* Additional options available only through the Dealer Code.

INSTALLER/DEALER SETTINGS

Setting	Default	Description
Loss of Cell Signal Timeout	30	Select the length in minutes (10-120) before reporting a loss in cellular signal
Communication Test	Monthly	Choose Never, Daily, Weekly or Monthly when enabling the communication test.
<p>SIA Limits</p> <p>Note: for UL/cUL set entry delay to 45 sec. and for UL set exit delay to max 120 sec. and for cUL set exit delay to 60 sec.</p>	Enabled	<p>When enabled, the range for entry and exit delays is as follows: -Entry delay: 30-240 seconds, Exit Delay: 45-254 seconds When disabled, the range for entry and exit delays are as follows: -Entry delay: 5 to 240 seconds, Exit delay: 5 to 254 seconds</p> <p>When enabled the range for Dialer Delay is: 15 to 45 seconds When disabled the range for Dialer Delay is: 0 to 254 seconds</p>
Languages	English	Set the panel's primary language to English(USA), French(Canada), Spanish(Latin America)
Favorite Languages	English/Spanish	Set the Panel's language toggle to your favorite 2 languages using French, English or Spanish
Standby Button	Enabled	Turning this setting off completely disables the "Power Button" on the right side of the panel and all of it's functions. To re-enable this setting you must first check the box then follow the on screen prompts to press the "Toggle" switch in the back of the panel
6 Digit User Code	Disabled	This is a global setting for all codes used on the panel and changes the input from 4 digits to 6 digits. When enabled, a "00" will be appended to all existing 4 digit codes

INSTALLER/DEALER SETTINGS

Setting	Default	Description
Commercial Sensor and Device Names	Disabled	Enabling this features changes the sensor name vocabulary from residential naming to commercial naming.
Jam Detection*	Disabled	When enabled the system can detect when an unusual amount of RF signals are being transmitted leading to a potential panel malfunction. This event reports to the central station when enabled
Jam Detection Local Alarm* Note: Not evaluated by UL/cUL	Disabled	When enabled the system will sound a local alarm. "Jam Detection" must be active for this to function properly
RF Jam Sensitivity Level*	Normal	Choose between HIGH and NORMAL sensitivity levels
Allow Master Code to Access Security Sensors	Disabled	Allow the Master Code to access to the Security Sensor icon, including Auto Learn Sensor, Add Sensor, Edit Sensor, Delete Sensor, Sensor Status & Sensor Group
Open/Close Reports Allowed For Auto Learn	Enabled	Rather than sending a tamper to auto learn a sensor, enabling this will allow an open/close of the sensor to trigger auto learn
Panel Glass Break Detector	Disabled	Creates an independent zone that leverages the panel's built-in microphones to act as a glass break detector. This will fall into the zone order at the time you enable this feature

INSTALLER/DEALER SETTINGS

Setting	Description	
Panel Motion Detector	Disabled	Creates an independent zone that leverages the panel's built-in camera to act as an activity motion detector. This will fall into the zone order at the time you enable this feature. Motion can trip once every 4 minutes. <i>Please note: The panel motion detector is for activity monitoring and automation only (Group 25) and will not create an alarm condition or act as a security PIR.</i>
Wi-Fi Warning Messages	Enabled	When enabled the panel will display a pop up when entering "Settings" letting the end user know that Wi-Fi has been disconnected.
Partitions	Disabled	Create up to 4 partitions by enabling this feature
Global Fire Siren	Disabled	When Partitions are enabled you may choose to enable this option to sound Fire alarms across all partitions
Delete All Sensors	Deletes all security sensors and Bluetooth devices programmed in the panel	
Delete All Z-Wave Devices	Deletes all Z-Wave devices programmed in the panel. This does not clear the device	
Master Reset*	Restores panel to factory settings and erases all content	
Data Recycle	This feature erases all User data previously stored	
Reset Panel With Last Backup Image*	Restore the Panel software with the last backup image	

SYSTEM LOGS



System logs allow the panel to send non-customer identifying information to the server for troubleshooting and bug identification.

Setting	Default	Description
Upload logs to the server	<i>Requires manual push</i>	Tell the panel to begin uploading a history of it's activity to the server. This information is used to troubleshoot bugs and diagnose panel problems. The panel will upload any logs saved in it's memory
Auto Upload Logs	Disabled	Automatically upload the system's log to the servers every 24 hours
Log Level	Debug	<p>Tell the panel how much information to record in log files.</p> <p>No log output: No information recorded Fatal: Record fatal or severely problematic information only Error: Record all errors and fatal issues Warn: Record warnings, errors, and fatal issues Info: Record all generic, non-customer related information Debug: Record diagnostic messages, Info, Warnings, Errors, and Fatal issues Verbose: Record all non-customer identifying information</p>

FIND IT

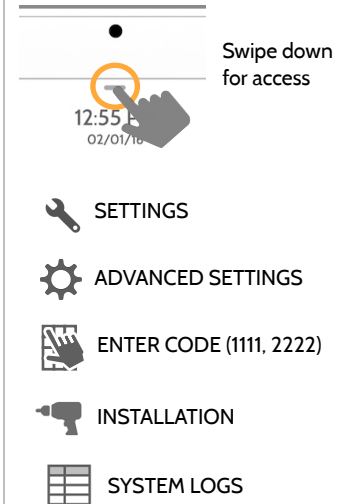

SIREN AND ALARMS



Siren and Alarms

Change siren and alarm settings for certain types of alarm events.

Setting	Default	Description
Panel Sirens	All Sirens On	<p>All Sirens Off: This will disable the siren for all alarm types including any paired or hardwired external sirens. After 30 mins the fire siren will be re enabled.</p> <p>All Sirens On: This is the default setting which enables the siren for all alarms</p> <p>Installer/Test Mode: This disables the siren for all alarm types including any paired or hardwired external sirens for 30 mins then all sirens are re-enabled</p>
Siren Annunciation	Disabled	<p>Panel siren pauses periodically to announce which locations have triggered the alarm.</p> <p><i>UL Note: for UL/CUL this feature is not allowed for Fire, CO, Burglar Alarm</i></p>
Fire Verification	Disabled	When enabled, panel requires two fire events from smoke detector (one detector twice or two detectors once each)
Severe Weather Siren Warning	Enabled	When enabled, siren will sound when the panel receives a severe weather alert. When disabled, panel will use severe weather chime

FIND IT

Swipe down for access

12:55
02/01/16

- SETTINGS
- ADVANCED SETTINGS
- ENTER CODE (1111, 2222)
- INSTALLATION
- SIREN AND ALARMS

SIREN AND ALARMS

Setting	Default	Description
Dialer Delay	:30	Amount of time (in seconds) before panel will attempt call to central station after an alarm event is triggered When SIA Limits enabled: :15 to :45 seconds When SIA Limits disabled: :0 to :254 seconds
Siren Timeout	4 min	Determine how long before siren stops sounding during an alarm event (4 minutes to 8 minutes). <i>For UL/cUL the minimum bell time out shall be set to 5min.</i>
Water/Freeze Siren	Disabled	When enabled, siren will sound when a water or freeze detector is triggered. When disabled, the panel emits a “water” tone
Police Panic	Enabled	Allows Police Panic to be enabled or disabled
Fire Panic	Enabled	Allows Fire Panic to be enabled or disabled
Auxiliary Panic	Enabled	Allows Auxiliary Panic to be enabled or disabled
Allow Master Code To Access Siren and Alarms	Disabled	Allow the master code to access these features and settings. <i>Note: not allowed for UL/cUL.</i>

SECURITY AND ARMING

FIND IT



Security and Arming

Change arming settings, entry and exit delays, enable Duress Authentication and more.

Setting	Default	Description
Dealer Code*	2222	Code to access all options
Installer Code	1111	Code to access installer options only
Swinger Shutdown	Enabled	Determines whether the panel allows the same sensor to trip the alarm more than once (enabled), or not (disabled)
Swinger Shutdown Count	1	Determines the number of times the same sensor is allowed to trip the alarm during the same arming period (1-6). Swinger Shutdown must be enabled in order for this setting to work
Panel Tamper	Enabled	This setting enables or disables the Panel Tamper switch on the back of the panel <i>UL Note: for UL/cUL this setting shall be Enabled</i>
Secure Arming	Disabled	Require user code for arming panel. <i>Note: this option shall be enabled for UL/cUL.</i>

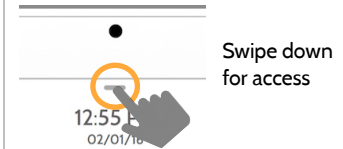

SETTINGS



ADVANCED SETTINGS



ENTER CODE (1111, 2222)



INSTALLATION



SECURITY AND ARMING

* Additional options available only through the Dealer Code.

SECURITY AND ARMING

FIND IT



Security and Arming

Change arming settings, entry and exit delays, enable Duress Authentication and more.

Setting	Default	Description
Refuse Arming When Battery Low	Disabled	Will not allow panel to arm if battery is low (below 8%)
Auto Bypass	Enabled	Toggle whether or not to bypass open or tampered sensors automatically. <i>Note: Shall be disabled for UL/cUL.</i>
Auto Stay	Enabled	If panel is armed "Away" but a delay door is not opened, the panel assumes you are still home and changes arming to "Stay" mode
Arm Stay - No Delay	Enabled	Arm stay immediately with no countdown timer
Auto Exit Time Extension	Enabled	Automatically extend countdown timer if delay door is opened during countdown process a second time
Keyfob Instant Arming	Enabled	When enabled, turns off exit delay if keyfob is used to arm the system
Keyfob Alarm Disarm	Disabled	When enabled this will Allow a keyfob to disarm alarm events, except panics originating from the same key fob
Keyfob Disarming	Enabled	When Disabled, a Keyfob will not be able to disarm the panel

Swipe down for access

12:55
02/01/16

- SETTINGS
- ADVANCED SETTINGS
- ENTER CODE (1111, 2222)
- INSTALLATION
- SECURITY AND ARMING

SECURITY AND ARMING

FIND IT

Setting	Default	Description
Allow Master Code to Access Security and Arming	Disabled	Allow the master code to access these features and settings. <i>Note: this option shall be disabled for UL/cUL.</i>
Normal Entry Delay	30 Secs	How much time users have to enter their code after opening a door (30-240secs). With SIA limits disabled the minimum time can be set to 5 secs
Normal Exit Delay	60 Secs	How much time users have to exit the location before the panel arms itself (30-254secs). With SIA limits disabled the minimum time can be set to 5 secs. Door/Window group 10 follows the "Normal Exit Delay"
Long Entry Delay	100 Secs	A second separate entry delay that can be used on a sensor needing more time when tripped (45-240secs). With SIA limits disabled the minimum time can be set to 5 secs
Long Exit Delay	120 Secs	A second separate exit delay that can be used on a sensor needing more time when tripped (45-254secs). With SIA limits disabled the minimum time can be set to 5 secs. Door/Window group 12 follows the "Long Exit Delay"

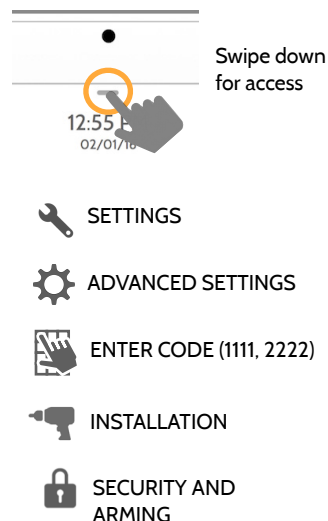

CAMERA SETTINGS



Camera Settings

Enable/Disable Disarm photos and Alarm photos. Secure images requiring a code to either view or delete.

Setting	Default	Description
Secure Delete Images	Enabled	When enabled, a code is required to delete disarm and image sensor photos
Disarm Photos	Enabled	When enabled, the built-in camera will take a single photograph when a user disarms the panel. When disabled, the panel will not capture images upon disarm
Alarm Photos	Enabled	When enabled, the built-in camera will take a single photograph during an alarm event
Alarm Videos	Enabled	When an alarm is triggered the panel will record a video clip for 4 mins from it's built in 5mp panel camera
Settings Photos	Disabled	Whenever Advanced Settings are accessed the panel will take and store a photo
Allow Master Code to Access Image Settings	Disabled	Allow the master code to access these features and settings

FIND IT



SETTINGS



ADVANCED SETTINGS



ENTER CODE (1111, 2222)



INSTALLATION



CAMERA SETTINGS

Note: Supplementary feature not evaluated by UL/cUL

Z-WAVE DEVICE LIST*

FIND IT



Z-Wave Device List

Shows device specific information for programmed Z-Wave devices.

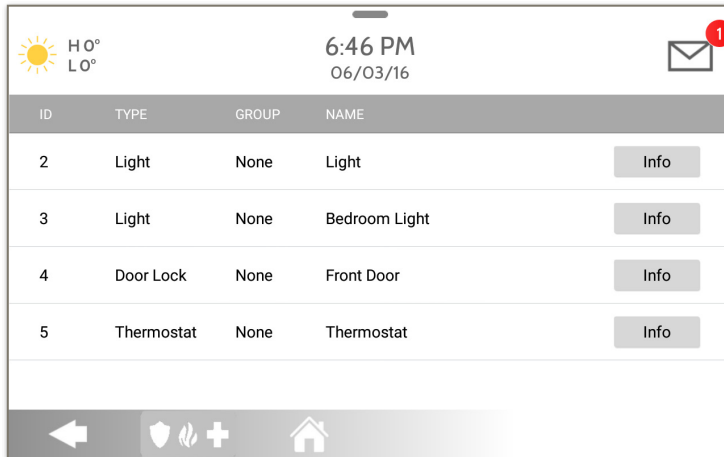



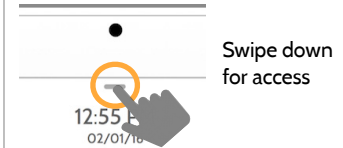

ID	TYPE	GROUP	NAME	Info
2	Light	None	Light	Info
3	Light	None	Bedroom Light	Info
4	Door Lock	None	Front Door	Info
5	Thermostat	None	Thermostat	Info

By pressing “Info” you will find the following information for that selected device.

- Product Info**
- Protocol Info**
- Application Info**
- Supported Command Class**



-  SETTINGS
-  ADVANCED SETTINGS
-  ENTER CODE (1111, 2222)
-  Z-WAVE DEVICE LIST

*This page only available through the Dealer Code.

SOUND



Sound

Customize panel sounds. Enable/Disable voices, chimes, trouble beeps and more.

Setting	Description
Volume	Controls the panel's voice volume, beeps and chime volume and the media volume (help videos) through individual sliders
Edit Chimes	Allows you to select from various chimes for each individual device
Voice Settings	Indicates whether the panel should "speak." Sensors, Panel messages, Activity Monitoring Sensors, and Z-Wave device actions can all be toggled independently. (unchecking a box disables the individual feature, unchecking the primary box disables all)
Chime Settings	Indicates whether the panel should emit tones/beeps. Sensors, Panel and Activity Monitoring Sensors can all be toggled independently. (unchecking box disables feature)
All Trouble Beeps	Toggles all sensor and panel trouble beeps on or off. By default all trouble beeps are disabled

FIND IT

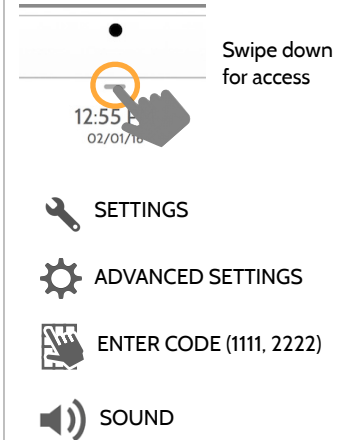

SOUND

Setting	Description
Sensor Low Battery	Panel sounds when a sensor battery is low. Chime type and frequency are set below. By default these sounds are disabled
Sensor Tamper Beeps	Panel sounds when a sensor is tampered. Chime type and frequency are set below. By default these sounds are disabled
Panel Tamper Beeps	Panel sounds when tampered or opened. Chime type and frequency are set below. By default these sounds are disabled
Edit Trouble Beep Chimes	Select the chime type for Sensor Low Battery, Sensor Tamper, and Panel Tamper
Trouble Beeps Timeout	Determines the amount of time between each trouble beep. Length can be set between 3-60 mins. (default is 30 mins)
Fire Safety Device Trouble Beeps	Panel will sound a trouble alert if a fire safety device is tampered, failed or has a low battery (disabled by default)
Touch Sounds	When touching an option the screen will make a sound. This is enabled by default

PARTITIONS*



Partitions

Edit the default name of a partition and view a list of users and sensors that are currently assigned to a given partition. Partitions 1, 2, 3 & 4 only appear when Partitions are enabled and when at least one sensor is learned into them.

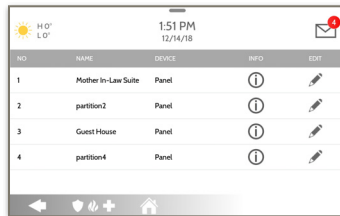

Overview:

View the number of partitions set up on a system. There must be at least one sensor assigned to a partition before it can be viewed/edited

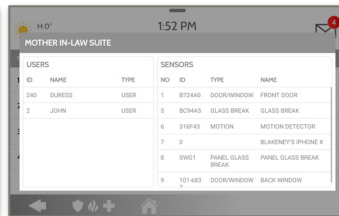

Info:

View Users and Sensors associated with each partition

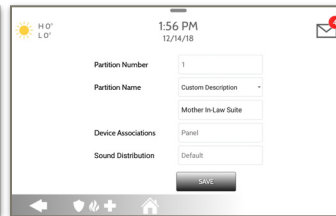

Edit:

Rename a partition that suits its location or area being protected

FIND IT

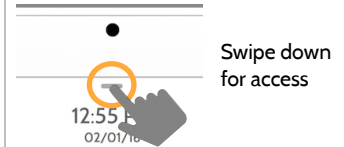

SETTINGS



ADVANCED SETTINGS



ENTER CODE (1111, 2222)



PARTITIONS

* The "Partitions" icon will only appear if Partitions are enabled under Installer/Dealer Settings

LOCAL AUTOMATION*



Local Automation

This hardcoded scene is designed for Panels installed in new construction properties that do not yet have an Alarm.com account activated, but that need to manage Z-Wave devices locally in a “vacant home mode”.

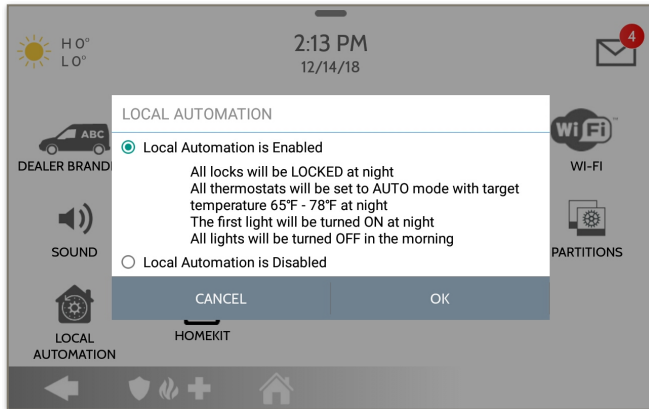

Runs Daily:

- Automatically LOCK all locks at night (8pm)
- Set all thermostats to AUTO mode with a target temperature of 65°F - 78°F
- Turn Light 1 ON at night (8pm) and then turn all lights OFF in the morning (6am)

FIND IT

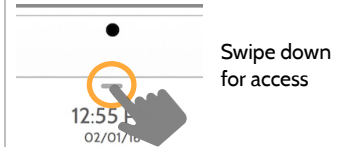

SETTINGS



ADVANCED SETTINGS



ENTER CODE (1111, 2222)



LOCAL AUTOMATION

*This page only available through the Dealer Code.

DEVICES

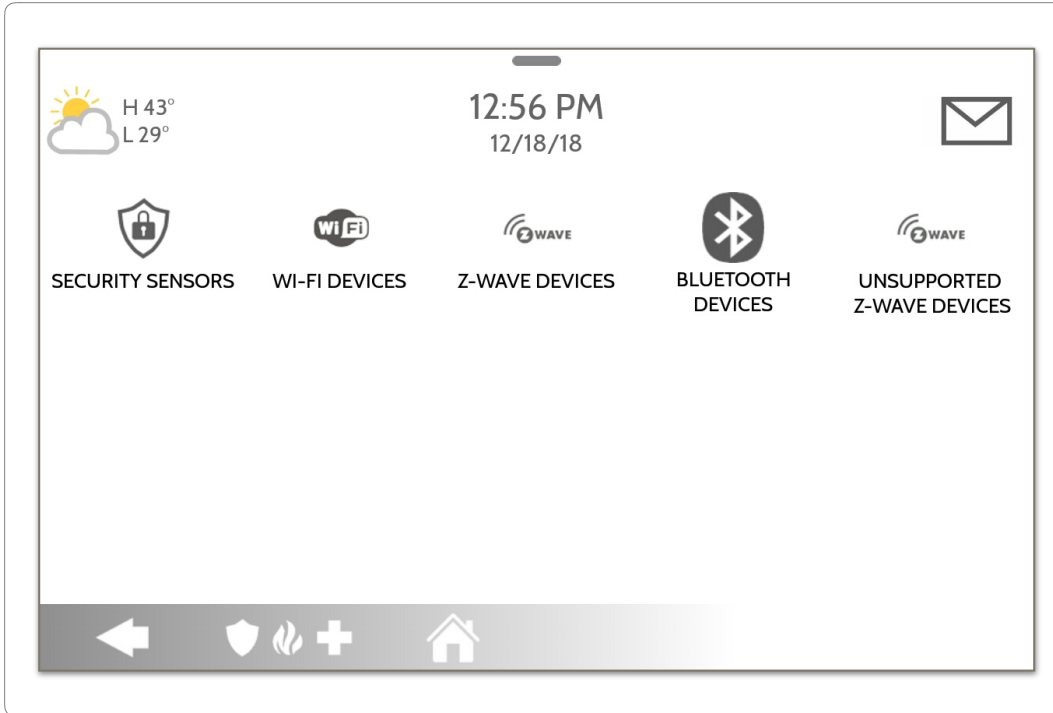

FIND IT

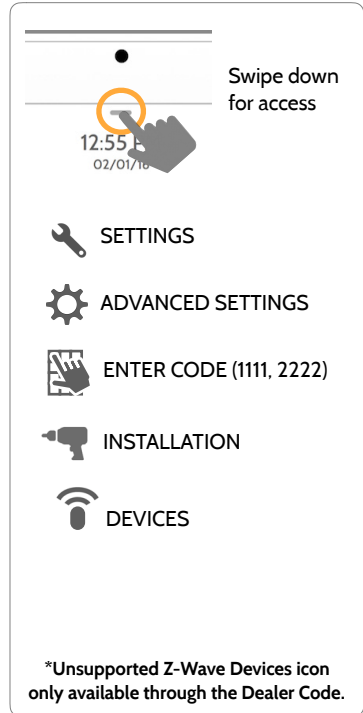

SECURITY SENSORS

SECURITY SENSORS



Security Sensors

Add, edit or delete up to 128 security RF or life safety devices. This includes support for Image Sensors, when Image Sensor Daughter Card is installed.



Auto Learn Sensor

Pair sensors quickly by tripping or tampering and then editing the information



Add Sensor

Pair sensors manually by typing in a DL code or Serial number



Edit Sensor

Make changes to existing sensors



Delete Sensor

Remove sensor



Sensor Status

Monitor sensor status in realtime



Sensor Group

Quick reference to all sensor groups and their actions



Remove All PowerG Sensors

Delete all PowerG sensors from the Panel

Note: image sensor functionality has not been investigated by UL/cUL. This is a supplementary feature that does not interfere with mandatory life safety and security protection operation of the alarm system control unit.

FIND IT

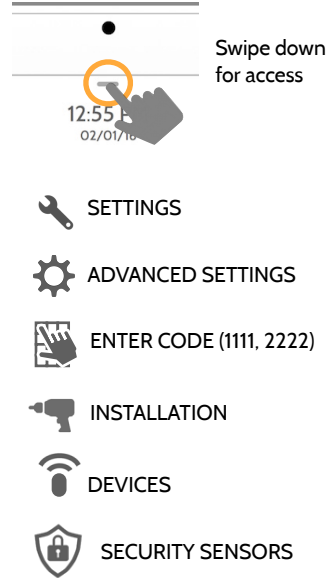

AUTO LEARN SENSOR

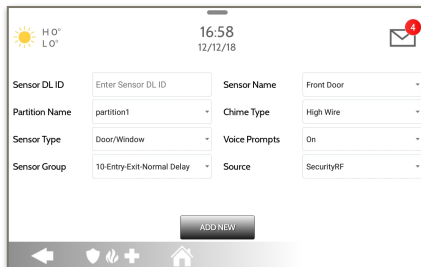
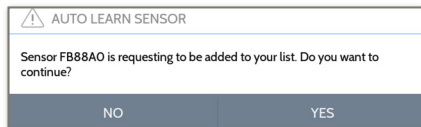

1. Select "Auto Learn Sensor"

2. Open/Close or Tamper a sensor to enroll. Image sensors have a 2 min enrolling window. For contacts **HARDWIRED** into "Sensor 1 or 2" on the back of the panel, simply open the contact. For PowerG contacts, hold the "enroll" button until the yellow LED flashes.

3. Panel will chime and display the sensor's DL code, or HW1/HW2 for hardwired contacts. Select OK to confirm.

4. Configure sensor group, name, chime and partition etc. with smart filtering drop down lists.

5. Select "Add New" to complete and move to the next sensor.

NOTE: The hardwire inputs on the panel can only be programmed as a Door/Window, Motion or Glass Break "Sensor Type".

When enrolling an "S-Line" sensor, the panel will auto detect that it's encrypted and change the "Source" field to S-Line.

IQ Panel 2+ only: When enrolling a sensor of a different frequency (345MHz, 433MHz, PowerG) the Source field will change to accommodate the incoming signal type.

When a sensor with the frequency 345 is used, you will be given an additional field to specify the Loop #.

ADD SENSOR



Sensor DL ID	<input type="text" value="Enter Sensor DL ID"/>
Partition Name	<input type="text" value="partition1"/>
Sensor Type	<input type="text" value="Door/Window"/>
Sensor Group	<input type="text" value="10-Entry-Exit-Normal Delay"/>
Sensor Name	<input type="text" value="Front Door"/>
Chime Type	<input type="text" value="High Wire"/>
Voice Prompts	<input type="text" value="On"/>
Source	<input type="text" value="SecurityRF-319"/>

Add New

1. Select “**Add Sensor**” (NOTE: These same fields can be edited later from the “*Edit Sensor*” app)
2. Select the appropriate **Source** based on the frequency of device being manually learned in
3. Tap the field marked “**Sensor DL ID**” to open the keyboard. Enter the DL code or Sensor ID on the back of the device and touch “Done”
4. Use the drop down menu to select which **Partition** you would like the sensor to be added to.
5. Choose **Sensor Type** from list
6. Indicate **Sensor Group** from list
7. Choose **Sensor Name** from the list or create a “Custom Name” using the built in keyboard with Custom Text to Speech.
8. Choose **Chime Type** from list
9. Indicate whether you want **Voice Prompts** on or off
10. Click “**Add New**” to save the information and complete the process.

PARTITIONS

When Partitions are enabled (see Dealer/Installer Settings) you may then assign a sensor to a specific partition. This will allow independent control and arming of that partition without disrupting the main panel's master partition. You may create and use up to 4 partitions.

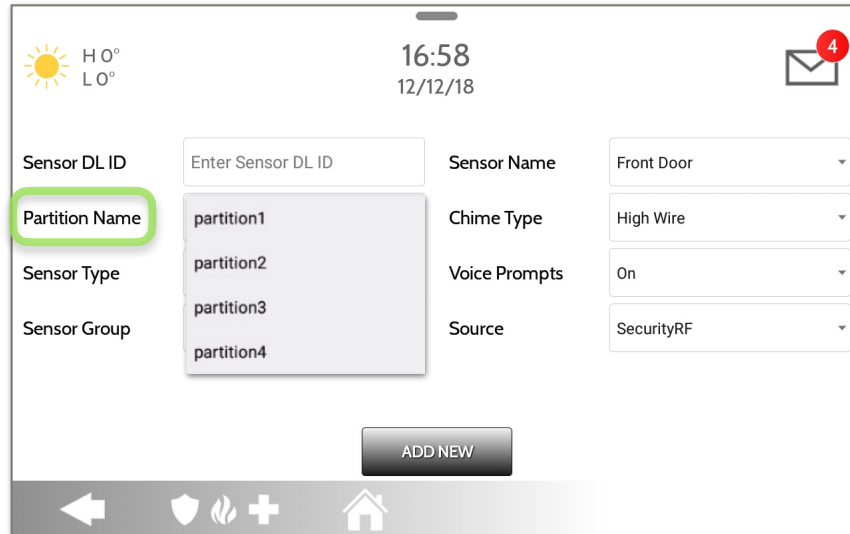

Sensor DL ID:
 Sensor Name:

Partition Name:
 Chime Type:

Sensor Type:
 Voice Prompts:

Sensor Group:
 Source:

SENSOR TYPE

When adding or editing security devices you can choose from the following sensor types:

- Door/Window
- Motion
- Glass Break
- Key Fob
- Keypad
- Auxiliary Pendant
- Smoke Detector
- CO Detector
- Hardwire Translator
- Wireless Translator
- Temperature*
- Heat
- Water
- Shock Sensor
- Freeze
- Tilt
- Image Sensor
- Door Bell
- Smoke-M
- Door/Window-M
- Occupancy Sensor
- Siren

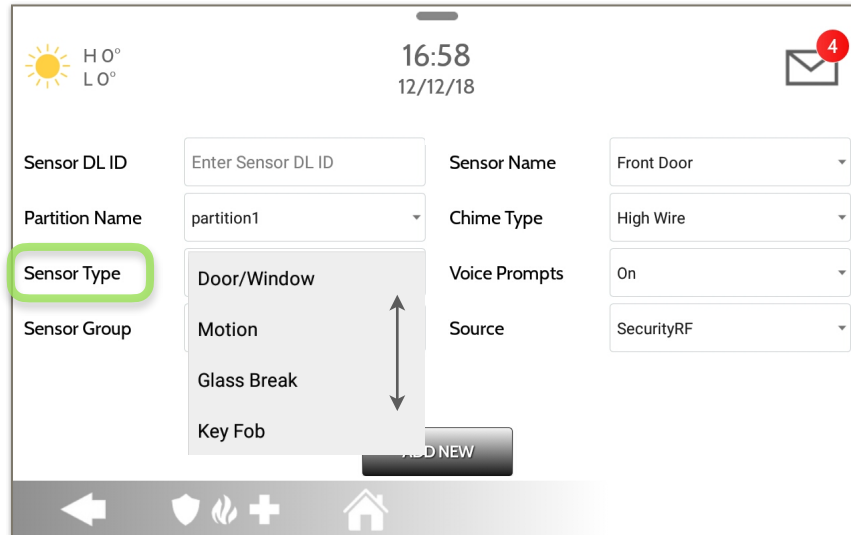

The screenshot shows a mobile application interface for adding a new security sensor. At the top, there is a weather icon, temperature (H 0°, L 0°), time (16:58), date (12/12/18), and a notification icon with a red '4'. Below this, there are several input fields and dropdown menus:

- Sensor DL ID:** Enter Sensor DL ID
- Sensor Name:** Front Door
- Partition Name:** partition1
- Chime Type:** High Wire
- Sensor Type:** (highlighted with a green box) - A dropdown menu is open showing options: Door/Window, Motion, Glass Break, and Key Fob.
- Voice Prompts:** On
- Sensor Group:** (empty)
- Source:** SecurityRF

At the bottom of the form, there is a button labeled "ADD NEW" and a navigation bar with icons for back, shield, fire, plus, and home.

*PowerG Devices Only

SENSOR GROUP

Sensor groups will change the behavior of the sensor. These are tied directly to your Sensor Type, displaying only what's relevant.

Touch the "Sensor Group" drop down to change.

A full list of Sensor Groups and descriptions can be found under "Sensor Groups" listed in the manual below.

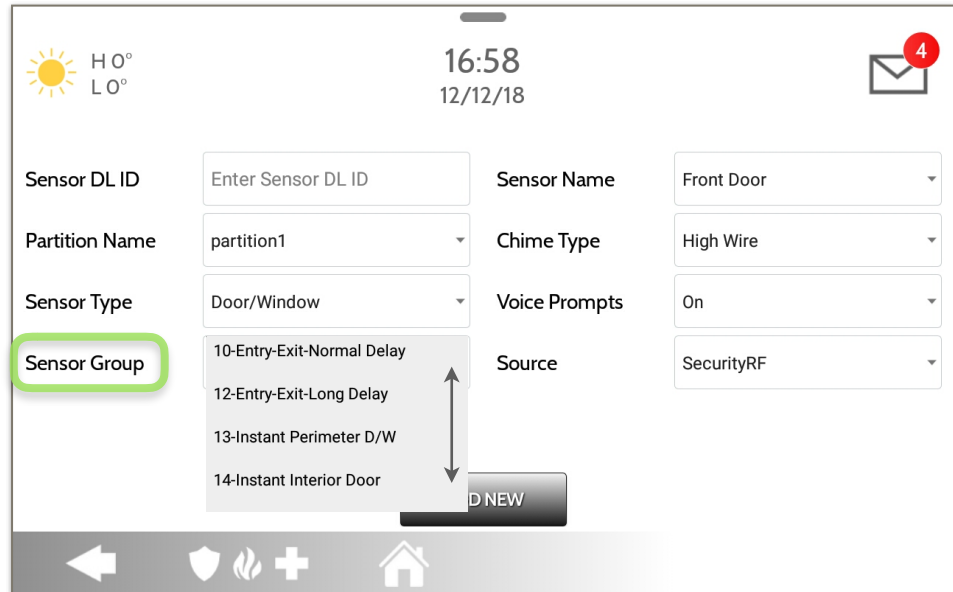

SENSOR GROUPS

IQ Panel 2+ supports PowerG along with ONE “legacy” frequency (319.5 MHz, 345 MHz, or 433 MHz) depending on which RF daughter card is pre-installed. Sensor Group numbers and behaviors remain the same across all frequencies. When pairing a 345 MHz sensor with the Panel, an additional option for “Loop” number will be shown.

DOOR/WINDOW

GROUP	NAME	SUPERVISED	SCENARIO
10	Entry-Exit- Normal Delay	Y	Gives a period of time to exit the home or to disarm the panel when returning before sounding the alarm
12	Entry-Exit- Long Delay	Y	Gives a period of time to exit the home or to disarm the panel when returning before sounding the alarm. This can be a separate delay from the “normal delay”
13	Instant Perimeter D/W	Y	Door or window that triggers an alarm instantly when system is armed
14	Instant Interior Door	Y	An interior sensor that triggers an alarm instantly while armed to both stay and away. Does not trip if an entry/exit sensor is tripped first
16	Away Instant- Follower Delay	Y	Interior door that triggers alarm instantly when system is armed to away mode only

DOOR/WINDOW

GROUP	NAME	SUPERVISED	SCENARIO
25	Local Safety Sensor	Y	This sensor does not report or trigger an alarm. This is a chime only sensor when "Activity Monitoring" is active, regardless of panel status. Used for medicine cabinets, chemical storage etc
8	Reporting Safety Sensor	Y	This sensor reports to the central station and triggers an alarm when "Activity Monitoring" is active, regardless of panel status
9	Delayed Reporting Safety Sensor	Y	This sensor reports to the central station and triggers an alarm when "Activity Monitoring" is active, regardless of panel status. This sensor has an entry delay

*345 MHz door/window sensors will have the option to change the "Loop" number to 1 or 2. This will allow the sensor to be programmed twice as 2 different zones.

* Power G Door/Window contact 9945 adds an additional drop down menu to determine the contact type, Reed Switch or Wired.

MOTION/IMAGE SENSOR

GROUP	NAME	SUPERVISED	SCENARIO
17	Away- Instant Motion	Y	Active only when armed to “Away”, and trips instantly when motion is detected. Does not trip if an entry/exit sensor is tripped first
15	Stay- Instant Motion	Y	Active in both “Stay” & “Away” modes, and trips instantly when motion is detected. Does not trip if an entry/exit sensor is tripped first
35	Stay- Delay Motion	Y	Active in both “Stay” & “Away” modes. Triggers an entry delay when motion is detected. Does not trip if an entry/exit sensor is tripped first
20	Away- Delay Motion	Y	Active when armed to “Away”. Triggers an entry delay when motion is detected. Does not trip if an entry/exit sensor is tripped first
25	Safety Motion	Y	This sensor does not report or trigger an alarm. This is a chime only sensor when “Activity Monitoring” is active, regardless of panel status. Used for medicine cabinets, storage, activity tracking, etc

*345 MHz motion sensors will have the option to change the “Loop” number to 1, 2 or 3. This will allow the sensor to be programmed twice as 2 different zones where supported by the device.

*Power G Motion Detectors with Prefix 120, 122, 130, 140 and 142 offer additional functions such as Presence Detection and Sensitivity Level. Motions with prefix 123, 127, 128 and 129 offer Presence only as an additional function.

GLASS BREAK

*345 MHz glass break sensors can be programmed as “Loop” 1 only

GROUP	NAME	SUPERVISED	SCENARIO
13	Glass Break	Y	Active in both “Stay” and “Away” mode
17	Glass Break -Away Only	Y	Active in “Away” mode only

KEY FOB

*345 MHz Keyfobs will follow the IQ Panel’s Keyfob programming and functionality

GROUP	NAME	SUPERVISED	SCENARIO
1	Mobile Intrusion	N	Worn or carried , the button(s) is/are programmed to trigger a police panic
6	Mobile Auxiliary	N	Worn as a wrist watch or pendant, the button(s) is/are programmed to trigger an Auxiliary panic. <i>UL NOTE: Medical functionality has not been evaluated by UL/cUL</i>
4	Fixed Auxiliary	Y	Installed in a fixed location such as night stand, the button(s) is/are programmed to trigger an Auxiliary panic. <i>UL NOTE: Medical functionality has not been evaluated by UL/cUL</i>

KEYPAD

GROUP	NAME	SUPERVISED	SCENARIO
0	Fixed Intrusion	Y	Installed in a fixed location such as under a desk, the button(s) is/are programmed to trigger a police panic . UL NOTE: Hold-up functionality has not been evaluated by UL/cUL
1	Mobile Intrusion	N	Keypad can be mobile and is programmed to trigger a police panic
2	Fixed Silent	Y	Installed in a fixed location such as under a desk, the button(s) is/are programmed to trigger a silent police panic

AUXILIARY PENDANT

*345 MHz auxiliary pendants can be programmed as “Loop” 1 only

GROUP	NAME	SUPERVISED	SCENARIO
6	Mobile Auxiliary	N	Worn as a wrist watch or pendant, the button(s) is/are programmed to trigger an Auxiliary panic
1	Mobile Intrusion	N	Worn or carried, the button(s) is/are programmed to trigger a police panic
0	Fixed Intrusion	Y	Installed in a fixed location such as under a desk, the button(s) is/are programmed to trigger a police panic
2	Fixed Silent	Y	Installed in a fixed location such as under a desk, the button(s) is/are programmed to trigger a silent police panic
4	Fixed Auxiliary	Y	Installed in a fixed location such as night stand, the button(s) is/are programmed to trigger an auxiliary panic
25	Safety Auxiliary Pendant	N	Used for local alerts like a nurse call button. Will not report an alarm to the Central Station

*345 MHz smoke sensors will have the option to change the “Loop” number to 1, 2 or 3. This will allow the sensor to be programmed twice as 2 different zones where supported by the device

SMOKE DETECTOR/HEAT

GROUP	NAME	SUPERVISED	SCENARIO
26	Smoke-Heat	Y	Triggers an alarm when sensor detects smoke/rapid rise in heat

SMOKE-M

GROUP	NAME	SUPERVISED	SCENARIO
26	Smoke-Heat	Y	Triggers an alarm when sensor detects smoke or a rapid rise of heat. Use ONLY with Qolsys multi-sensor smoke (QS5110-840)

CO DETECTOR

*345 MHz carbon monoxide sensors can be programmed as “Loop” 1 only

GROUP	NAME	SUPERVISED	SCENARIO
34	CO	Y	Triggers an alarm when sensor detects Carbon Monoxide

HARDWIRE TRANSLATOR

GROUP	NAME	SUPERVISED	SCENARIO
13	Takeover	Y	Triggers an alarm when sensor is tampered in "Stay" or "Away" mode

WIRELESS TRANSLATOR

GROUP	NAME	SUPERVISED	SCENARIO
13	Translator	Y	Triggers an alarm when sensor is tampered in "Stay" or "Away" mode

TEMPERATURE

GROUP	NAME	SUPERVISED	SCENARIO
51	Temp Non Reporting	Y	Only for use with the PowerG Temp Sensor (PG9905). This sensor group does not report to the Central Station. Allows for actual temperature monitoring (thermometer) with customizable high/ low threshold settings

WATER

*345 MHz water sensors will have the option to change the “Loop” number to 1, 2 or 3. This will allow the sensor to be programmed twice as 2 different zones where supported by the device

GROUP	NAME	SUPERVISED	SCENARIO
38	Water Sensor	Y	Triggers an alarm when sensor detects presence of water. <i>UL NOTE: flood sensor functionality has not been evaluated by UL/cUL</i>

Please note: When selecting “Water” you will see two additional options under “Sensor Sub-Type”. For IQ TempH2O (QS5500-PO1) & the IQ Flood (QS5516-840/QS5536-840) select “Multi-Function-1”, for all others, select “Flood-2”

SHOCK SENSOR

*345 MHz shock sensors will have the option to change the “Loop” number to 1 or 3. This will allow the sensor to be programmed twice as 2 different zones where supported by the device

GROUP	NAME	SUPERVISED	SCENARIO
13	Shock-Glass-Break	Y	Arms and trips shock sensors immediately when armed to both “Stay” and “Away”
17	Glass-Break-Away Only	Y	Arms and trips shock sensors immediately when armed only to “Away”

Please note: When selecting “Shock” you will see two additional options under “Sensor Sub-Type” For IQ Shock select “IQ Shock”, for all others select “Other Shock”

*Power G Shock Sensor with prefix 170 offers additional sensitivity level functions

FREEZE

*345 MHz temp sensors can be programmed as “Loop” 1 only

GROUP	NAME	SUPERVISED	SCENARIO
52	Freeze	Y	Triggers an alarm when sensor detects low temperatures. <i>UL NOTE: temperature sensor functionality has not been evaluated by UL/cUL</i>

TILT

*345 MHz tilt sensors can be programmed as “Loop” 3 only

GROUP	NAME	SUPERVISED	SCENARIO
10	Entry-Exit- Normal Delay	Y	Triggers alarm after “normal delay” expires. Arms with both “Stay” and “Away”
12	Entry-Exit- Long Delay	Y	Triggers alarm after “long delay” expires. Arms with both “Stay” and “Away”
25	Garage Tilt- Safety Tilt	Y	This sensor group does not report or trigger an alarm. This is a chime only sensor when “Activity Monitoring” is active, regardless of panel status. Great for detached garage/shops. <i>UL NOTE: Functionality in conjunction with garage door openers has not been evaluated by UL/cUL</i>

DOOR BELL

GROUP	NAME	SUPERVISED	SCENARIO
25	Local Safety Sensor	Y	This sensor does not report or trigger an alarm. This is a chime only sensor when "Activity Monitoring" is active, regardless of panel status. Great to automate lights, cameras and notifications etc

SIREN

GROUP	NAME	SUPERVISED	SCENARIO
33	Siren	Y	Used for supervising Z-Wave sirens for wireless connectivity. Reports to the central station.
25	Local Safety Sensor	Y	Used for supervising Z-Wave sirens for wireless connectivity. Local supervision only. Does NOT report to the central station.

DOOR/WINDOW-M (For use only with Multi-function Door/Window Sensors)

GROUP	NAME	SUPERVISED	SCENARIO
10	Entry-Exit- Normal Delay	Y	Gives a period of time to exit the home or to disarm the panel when returning before sounding the alarm
12	Entry-Exit- Long Delay	Y	Gives a period of time to exit the home or to disarm the panel when returning before sounding the alarm. This can be a separate delay from the "normal delay"
13	Instant Perimeter D/W	Y	Door or window that triggers alarm instantly when system is armed
14	Instant Interior Door	Y	An interior sensor that triggers an alarm instantly while armed to both stay and away. Does not trip if an entry/exit sensor is tripped first
16	Away Instant- Follower Delay	Y	Interior door that triggers alarm instantly when system is armed to away mode only

DOOR/WINDOW-M (For use only with Multi-function Door/Window Sensors)

GROUP	NAME	SUPERVISED	SCENARIO
25	Local Safety Sensor	Y	This sensor does not report or trigger an alarm. This is a chime only sensor when "Activity Monitoring" is active, regardless of panel status. Used for medicine cabinets, chemical storage etc
8	Reporting Safety Sensor	Y	This sensor reports to the central station and triggers an alarm when "Activity Monitoring" is active, regardless of panel status
9	Delayed Reporting Safety Sensor	Y	This sensor reports to the central station and triggers an alarm when "Activity Monitoring" is active, regardless of panel status. This sensor has an entry delay

OCCUPANCY SENSOR

GROUP	NAME	SUPERVISED	SCENARIO
25	Occupancy Sensor	Y	This sensor group is to be used for monitoring activity in the home. This group does not report

SENSOR NAME

Sensor DL ID: **Sensor Name**

Partition Name: Chime Type

Sensor Type: Voice Prompts

Sensor Group: Source

Front Door
 Custom Description
 Front Window
 Back Door
 Back Window

ADD NEW

When you select the sensor name field you can choose from a variety of preset sensor names by scrolling up and down or create a custom description.

SENSOR NAME: CUSTOM DESCRIPTION

When you select “Custom Description” as your sensor name the android keyboard will appear. Type in the desired name (up to 24 characters) and click “Done.” The name will appear in the field below “Sensor Name.”

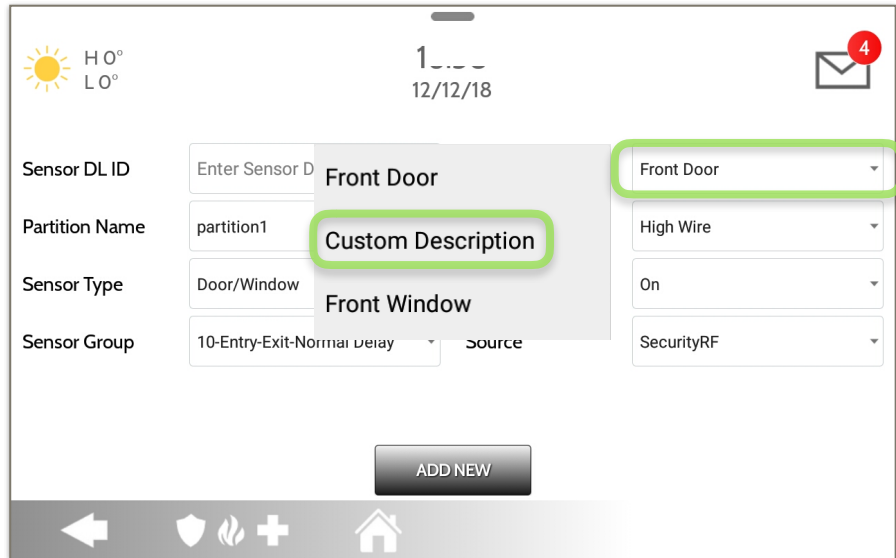

The screenshot displays the 'ADD NEW' sensor screen in the Golsys mobile application. At the top, there is a weather widget showing a sun icon, 'H 0°', 'L 0°', the time '1:00', and the date '12/12/18'. A notification icon with a red '4' is in the top right corner. The main form contains the following fields:

- Sensor DL ID:** A text input field containing 'Enter Sensor D'.
- Partition Name:** A text input field containing 'partition1'.
- Sensor Type:** A dropdown menu with 'Door/Window' selected.
- Sensor Group:** A dropdown menu with '10-Entry-Exit-Normal delay' selected.
- Sensor Name:** A dropdown menu with 'Front Door' selected. A green box highlights the 'Custom Description' option in the dropdown list.

At the bottom of the form is a dark grey button labeled 'ADD NEW'. Below the form is a navigation bar with icons for back, shield, plus, and home.

CHIME TYPE

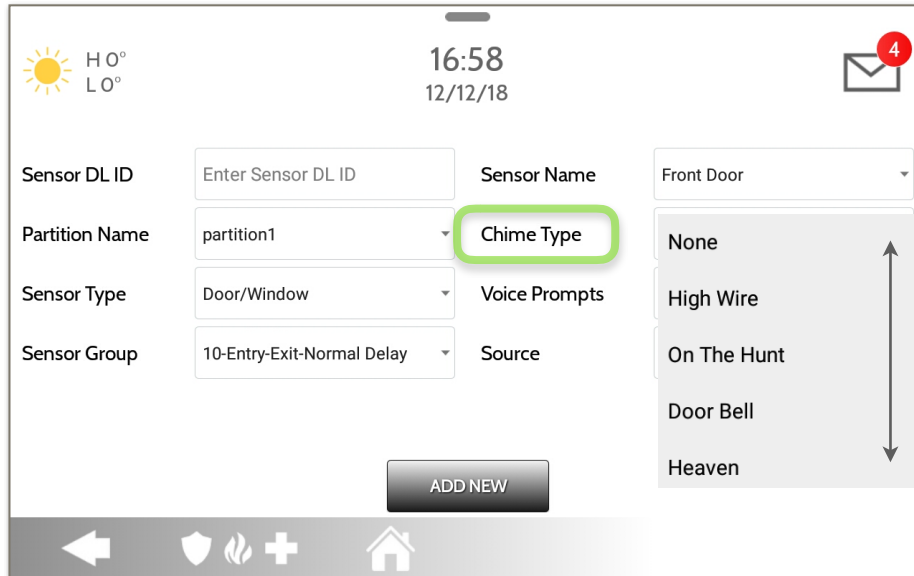

The screenshot shows a mobile application interface for configuring a security sensor. At the top, there is a weather widget showing a sun icon, 'H 0°', 'L 0°', the time '16:58', and the date '12/12/18'. A notification icon with a red '4' is in the top right. The main configuration area includes:

- Sensor DL ID:** Enter Sensor DL ID
- Partition Name:** partition1
- Sensor Type:** Door/Window
- Sensor Group:** 10-Entry-Exit-Normal Delay
- Sensor Name:** Front Door
- Chime Type:** A dropdown menu is open, showing options: None, High Wire, On The Hunt, Door Bell, and Heaven. The 'Chime Type' label is highlighted with a green box.
- Voice Prompts:** (Label visible, but no options shown)
- Source:** (Label visible, but no options shown)

An 'ADD NEW' button is located at the bottom center. A bottom navigation bar contains icons for back, shield, fire, plus, and home.

Because of the dynamic nature of the way the IQ Panel 2 pairs and understands each individual sensor, you can program each sensor to have a unique chime or even turn chiming off for that individual sensor. To customize your chime for a particular sensor touch the Chime Type drop down and choose from the list.

VOICE PROMPTS

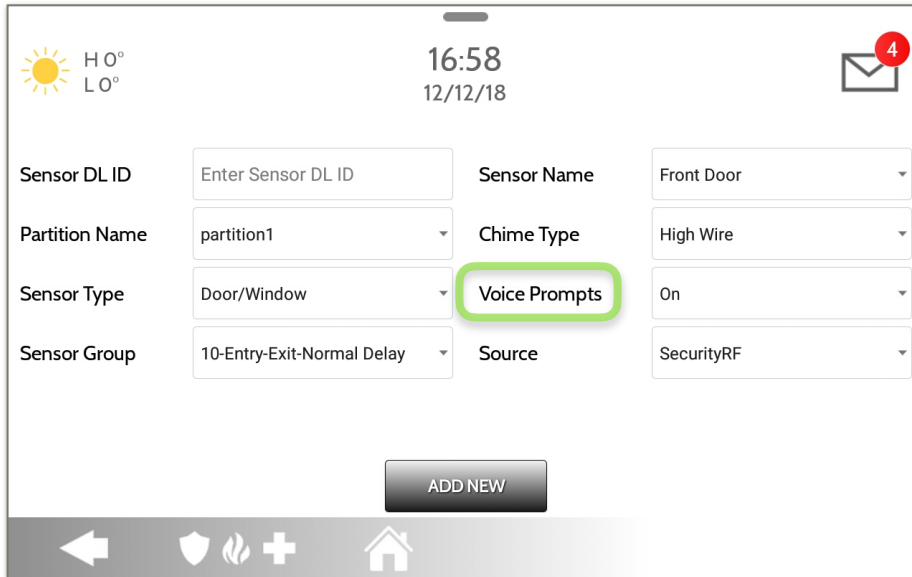

Sensor DL ID	<input type="text" value="Enter Sensor DL ID"/>	Sensor Name	Front Door
Partition Name	partition1	Chime Type	High Wire
Sensor Type	Door/Window	Voice Prompts	On
Sensor Group	10-Entry-Exit-Normal Delay	Source	SecurityRF

ADD NEW

Voice prompts announce the sensor name when the sensor is opened or tripped.*

For door/window sensors, voice prompts are defaulted to “On”. For most other sensors the default is “Off”. Touch the drop down menu to change.

Choose individually which sensors should have voice prompts ON or OFF

**NOTE: “Activity Monitoring Sensors” will also audibly report when they have been closed.*

SOURCE

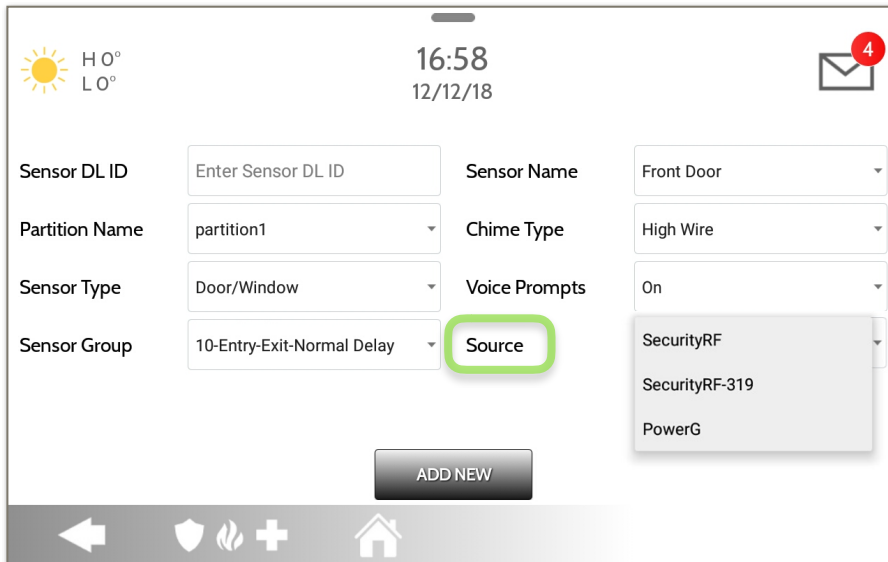

The screenshot shows a mobile application interface for adding a new sensor. At the top, there is a weather widget showing 'H 0°' and 'L 0°', a clock displaying '16:58' and the date '12/12/18', and a notification icon with a red '4'. Below this, there are several input fields and dropdown menus:

- Sensor DL ID:** A text input field containing 'Enter Sensor DL ID'.
- Sensor Name:** A dropdown menu with 'Front Door' selected.
- Partition Name:** A dropdown menu with 'partition1' selected.
- Chime Type:** A dropdown menu with 'High Wire' selected.
- Sensor Type:** A dropdown menu with 'Door/Window' selected.
- Voice Prompts:** A dropdown menu with 'On' selected.
- Sensor Group:** A dropdown menu with '10-Entry-Exit-Normal Delay' selected. The 'Source' option is highlighted with a green circle, and a dropdown menu is open below it showing 'SecurityRF', 'SecurityRF-319', and 'PowerG'.

At the bottom of the form is an 'ADD NEW' button. The bottom navigation bar contains icons for back, home, and other functions.

Source indicates the sensor's incoming frequency when pairing to the IQ Panel 2 and IQ Panel 2+.

For the IQ Panel 2 you will see traditional SecurityRF-319 for legacy sensors and S-Line for Golsys Encrypted sensors.

IQ Panel 2+ will show the following options depending on the pre-installed RF Daughter Card:

- PowerG
- SecurityRF-319
- S-Line
- SecurityRF-345
- 345RF 2G
- SecurityRF-433

WI-FI DEVICES

WI-FI DEVICES



Wi-Fi Devices

View and remove Wi-fi devices associated with the panel as well as configure the Qolsys Access point.



Wi-Fi

Scan and connect to a Wi-Fi network. This will ensure your panel can receive software updates and have a Dual Path connection.



Access Point Settings

Configure the IQ Panel 2's built in router. Enable/Disable the router, broadcast or hide the SSID and change the SSID's password etc...



Access Point Connected Devices

View connected device information such as IP, MAC address and for how long the device has been connected.



IQ Remote Devices

Pair an IQ Remote Secondary Touchscreen to the panel whether it is connected to the customer's network or the panel's built in Access Point.

FIND IT

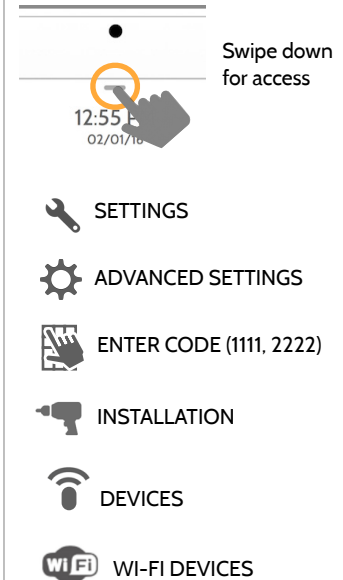

CONNECTING TO WI-FI



To connect to a Wi-Fi network, follow the steps below:

Swipe down from the top menu bar and select settings.



Touch Advanced Settings (Installer Code)



Then touch “Wi-Fi”



Enable Wi-Fi if not already active

Available networks appear in a list. Touch the desired network and use the keyboard to type the password (if required)

Activate WIFI



Qolsys-5G
Connected



Now Communications



Qolsys



Sunset Room



Vertical Ops 2.4



Add wi-fi network

FIND IT

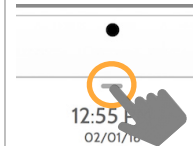

Swipe down for access



SETTINGS



ADVANCED SETTINGS



ENTER CODE (1111, 2222)



INSTALLATION



DEVICES



WI-FI DEVICES

ACCESS POINT SETTINGS

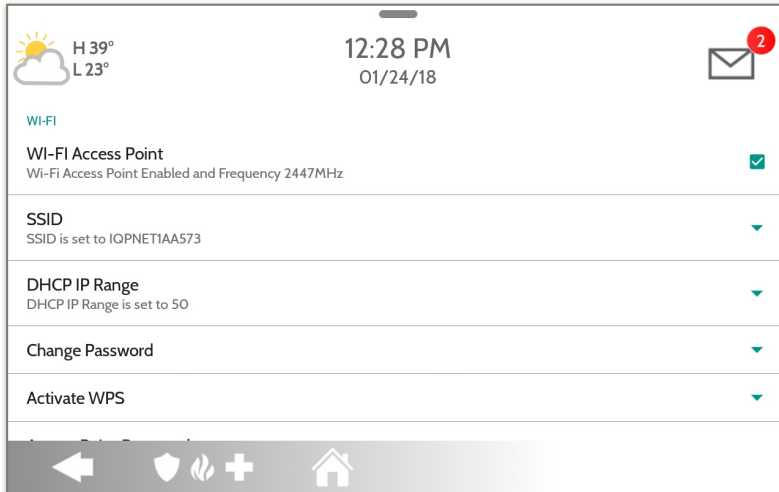

WI-FI Access Point:

Enable or Disable the Panel Access Point

SSID:

Change the SSID Name. This is the name that other devices will use to connect to.

DHCP IP Range:

Modify the DHCP IP Range for the access point. Default is 50.

Change Password:

Change the password of the SSID to one of your choosing.

Activate WPS:

Connect devices to the panel's built-in access point using WPS push button.

Access Point Password:

Shows current password in use for the Panel Access Point

ACCESS POINT CONNECTED DEVICES



H 59°
L 47°

4:41 PM
11/01/16



NO	MAC ADDRESS	IP ADDRESS	CONNECTED TIME(MM:DD:HH:MM)	ACTIONS
1	00:02:d1:42:19:48	192.168.50.80	00:00:00:04	□



View the IP address, Mac address and connected duration of each Wi-Fi client connected to the panel's built in router.

Select "Actions" to then remove a device that has been associated with the panel.

You must remove saved network information from the device otherwise it will re-connect to the panel.

IQ REMOTE DEVICES



IQ Remote Devices

Pair up to 3 IQ Remote Secondary Touchscreens to the panel via the customer's network or the panel's built in access point.

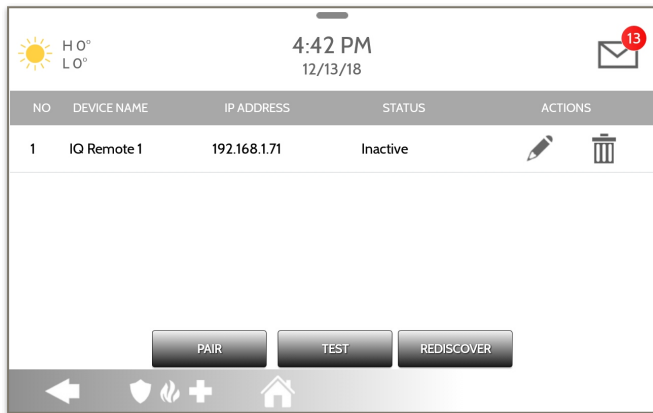

Note: The IQ Remote will automatically pair as Sensor Type "Keypad" and will appear on the zone list in the order in which it is paired. Sensor Groups 0, 1 & 2 are available options for this Sensor Type.

1. Connect the IQ Remote to the panel's access point or to the same Wi-Fi network the panel is connected to. *Please note: IQ Remote only supports 2.4Ghz networks*
2. Prior to pairing the IQ Remote to the panel you can Test the connection by select TEST on the panel and the remote.
3. Select "Pair" on the Panel and then Pair on the IQ Remote to begin during this process the remote will also download and update to the current software version and reboot.
4. The remote device will pair to the panel and will show that it is active on the list. You can then edit (device name and sensor group), ping, delete or rediscover the device if necessary

Z-WAVE DEVICES

Z-WAVE DEVICES



Z-Wave Devices

Add, Edit, Clear and Remove Z-Wave Devices. You can also View/Edit associations as well as access Z-Wave Settings.



Add Device

Pair new devices



Edit Device

Make changes to existing devices



Clear Device

Clears or resets the memory of a Z-Wave device. Also deletes a device from the IQ Panel 2 if currently paired. (Requires you touch the "Pair" button on the device)



Delete Failed Device

Remove a failed Z-Wave device from the IQ Panel 2's memory (does not require you to have the device)



Remove All Devices

Delete all Z-Wave devices from the IQ Panel 2's memory



View/Edit Associations

Manually change Z-Wave associations for specific devices.



Z-Wave Settings

Configure device limits and other Z-Wave settings.

ADD DEVICE



1. Select “Add Device”



INCLUDE

2. Touch “Include”

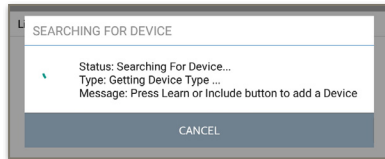

3. Press the “Pair” or “Learn” button on the device when the message appears. *(see individual device documentation for instructions on button location)*

4. Adjust the device name by touching and making the appropriate selections.

5. Select “Automation” to enable simple light rules.

- **Night:** Turns light on at 7pm and off at 6am
- **Evening:** Turns light on at 7pm and off at 11pm
- **Front Door:** Turns light on for 15mins when Front Door opens (must have a sensor with the default quick name “Front Door” added in the panel).

6. Click “Add” to save the information and complete the process. (Adjustments can be made later from “Edit Device” icon)

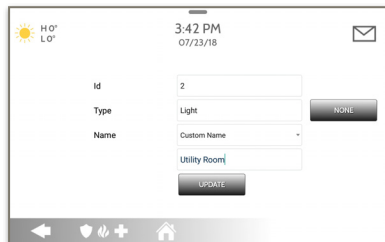

FIND IT

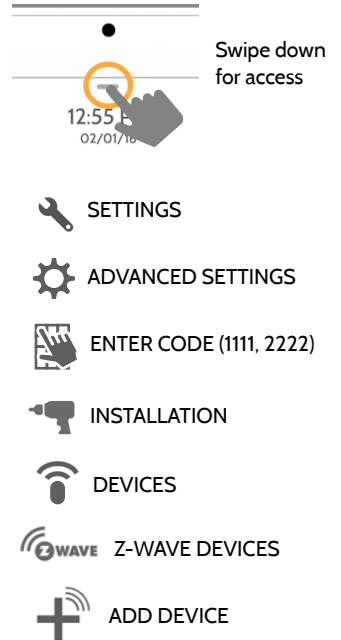

CLEAR DEVICE



Clears Z-Wave device from a network, whether it was enrolled with another controller previously or the IQ Panel 2. Also deletes a device from the IQ Panel 2 if currently paired.



Touch
"Clear Device"

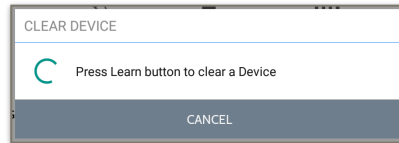

Panel will start sending a
"Clear" signal



Press
"Pair" or "Learn"
button on device*

Panel returns to
Z-Wave Device
menu when
complete

**Note: each Z-Wave device is different, and not all devices have a hard button to pair or learn. Refer to your device's installation manual for specifics on pairing or learning.*

DELETE FAILED DEVICE



Deletes Z-Wave device from the panel. This does not clear the device's memory. Before adding the device to another network see instructions on how to "Clear" a Z-Wave device. Only allows a Node ID to be deleted if it has failed and is no longer communicating.



Touch
"Delete Failed
Device From
Panel"

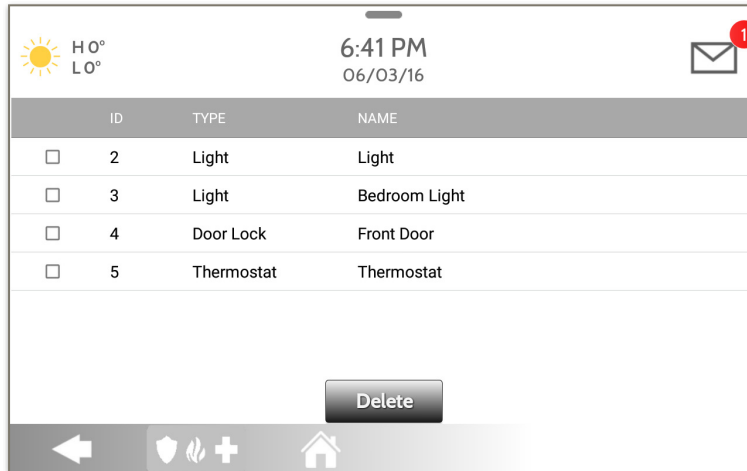

The screenshot shows a mobile application interface for managing Z-Wave devices. At the top, there is a weather widget showing a sun icon, high/low temperatures (H0°, L0°), the time (6:41 PM), and the date (06/03/16). To the right of the weather is a notification icon (envelope) with a red circle containing the number 1. Below the weather is a table with four rows of device information. Each row has a checkbox in the first column, followed by the ID, TYPE, and NAME. At the bottom of the table is a 'Delete' button. The bottom of the screen features a navigation bar with icons for back, home, and a shield with a plus sign.

	ID	TYPE	NAME
<input type="checkbox"/>	2	Light	Light
<input type="checkbox"/>	3	Light	Bedroom Light
<input type="checkbox"/>	4	Door Lock	Front Door
<input type="checkbox"/>	5	Thermostat	Thermostat

Check the boxes next to the
device(s) you want to delete



Touch "Delete"

REMOVE ALL DEVICES



Deletes all Z-wave devices from the panel and resets the panel's Z-Wave controller.

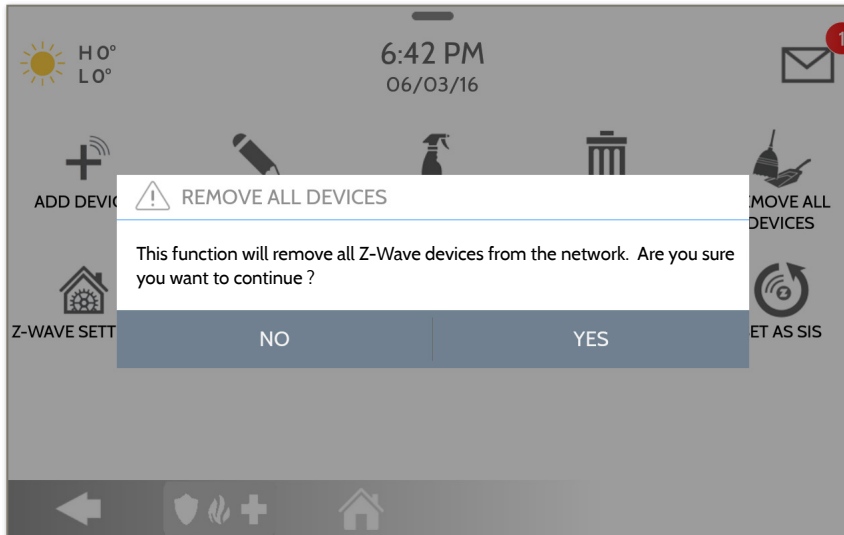

Touching "Remove All Devices" brings a confirmation pop-up asking you to confirm your decision to remove all devices.

This procedure will send a Device Reset to all Z-Wave devices associated with the IQ Panel 2 within the Lifeline association group (Association Group 1).

VIEW/EDIT ASSOCIATIONS



Manually change Z-Wave associations for specific devices.

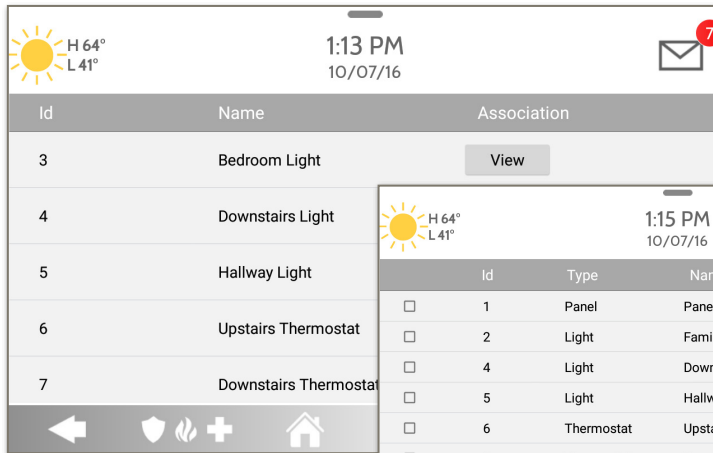

Id	Name	Association
3	Bedroom Light	View
4	Downstairs Light	
5	Hallway Light	
6	Upstairs Thermostat	
7	Downstairs Thermostat	

1. Select the Z-Wave device you would like to associate with another by touching "View"

2. Select "Edit"

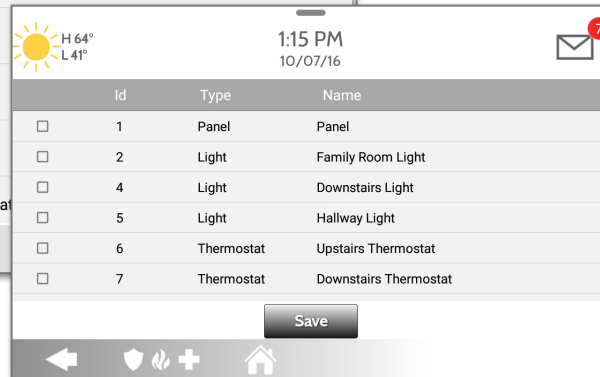
Id	Type	Name
<input type="checkbox"/> 1	Panel	Panel
<input type="checkbox"/> 2	Light	Family Room Light
<input type="checkbox"/> 4	Light	Downstairs Light
<input type="checkbox"/> 5	Light	Hallway Light
<input type="checkbox"/> 6	Thermostat	Upstairs Thermostat
<input type="checkbox"/> 7	Thermostat	Downstairs Thermostat

Save

3. "Check" the boxes next to each device that you would like to associate with. Then select "Save"

Z-WAVE SETTINGS

Z-Wave Settings allow an installer to set a maximum number of Z-Wave devices allowed on the IQ Panel 2 in all categories and to control other Z-Wave settings.

Device	Default	Maximum Number Supported
Thermostats	10	Maximum number of supported Thermostats is 10
Smart Sockets*	15	Maximum number of supported IQ Smart Sockets is 15
Lights	80	Max number of supported Z-Wave light modules is 80
Door Locks	20	Maximum number of supported Z-Wave Door Locks is 20
Other Z-Wave Devices	21	Maximum number of misc Z-Wave devices is 21
Garage Doors	6	Maximum number of Garage Doors is 6

Note: This feature has not been evaluated by UL/cUL. This is a supplementary functionality that will not interfere with the minimum mandatory operation of the life safety and burglary protection of the alarm system control unit. **UL Note:** Additional Z-Wave devices other than what has been indicated as maximum limits have not been evaluated by UL/cUL.

FIND IT

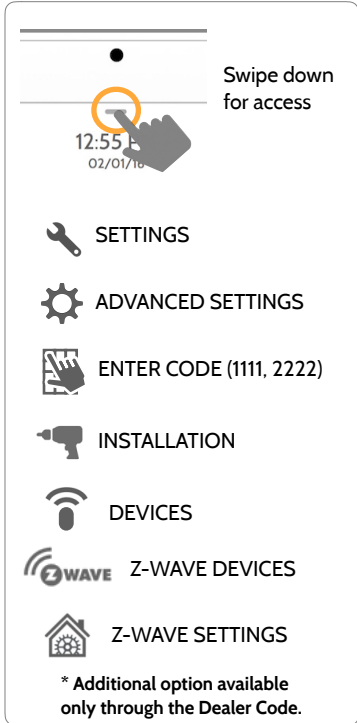

Z-WAVE SETTINGS

Setting	Default	Description
Allow Master Code Z-Wave Settings	Disabled	Allow Master User Code to access Z-Wave Settings
Allow Master Code Z-Wave Management	Disabled	Allow Master User Code to access Z-Wave Devices (Add, Edit, Clear, Delete Failed Device, Remove All Devices & View/Edit Associations)
Access to Automation	Enabled	When enabled it allows the ability to apply simple automated actions to lights and switches directly from the panel
Z-Wave	Enabled	Activate or deactivate the Z-Wave radio. Please use this procedure only when the controller (panel) is missing or inoperable
Advanced Z-Wave Settings	Disabled	<p>When Advanced Z-Wave Settings is enabled the following new icons will appear on the Z-Wave Devices page:</p> <ul style="list-style-type: none"> - Continuous Add Devices: Activates an “always listening” enroll mode. Include one Z-Wave device after another. When complete you can edit the device(s) with a custom name - Replace Failed Node: Allows a node that has failed to be replaced with a new device using the same node ID - Manage Devices From Secondary Controllers: Allows secondary controllers to manage devices on the network - Controller Shift: Shifts the primary controller from IQ Panel to another controller - Add/Remove Controller: This icon acts like an “Add/Remove” button when pairing the IQ Panel into another network

BLUETOOTH DEVICES

BLUETOOTH DEVICES

FIND IT



Bluetooth Devices

Add, Edit, Delete and Configure a Bluetooth Device. Bluetooth disarm supported via a mobile device. Bluetooth Chime, announcement and 2 Way Voice supported on Anker 3102 Bluetooth speaker.



Add Device

Pair up to 5 mobile Bluetooth devices.



Edit Device

Make changes to existing Bluetooth devices.



Delete Device

Delete a paired Bluetooth device



Remove All Devices

Removes all paired Bluetooth devices at once.



Settings

Toggle Bluetooth on/off, adjust Bluetooth disarm settings and change Bluetooth disarm timeout (1,5,10,20 & 30mins).



Add Speaker

Pair an Anker a3102 Bluetooth speaker with the panel for remote voice announcements, chimes and two-way voice.

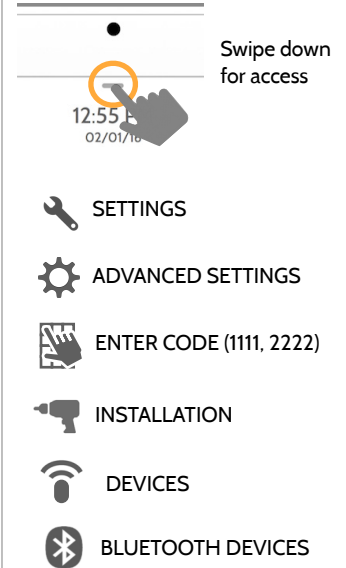

ADD DEVICE

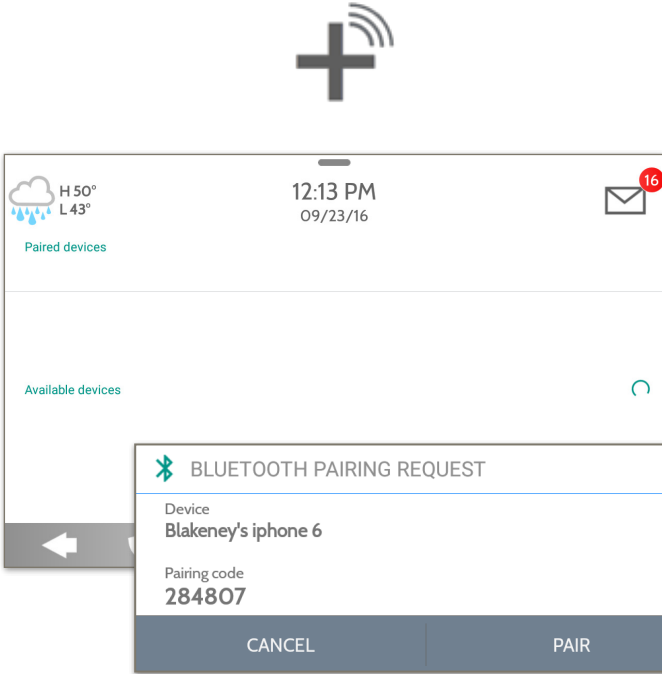

A screenshot of a mobile application interface. At the top, there is a large plus sign with a Bluetooth symbol. Below it, a weather widget shows 'H 50° L 43°' with a cloud and rain icon. The time is '12:13 PM' and the date is '09/23/16'. There is a notification icon with '16'. Below the weather, there are sections for 'Paired devices' and 'Available devices'. A 'BLUETOOTH PAIRING REQUEST' dialog box is overlaid on the screen, showing the device name 'Blakeney's iphone 6' and the pairing code '284807'. The dialog has 'CANCEL' and 'PAIR' buttons at the bottom.

1. Select “Add Device”
2. Open the Bluetooth page on your mobile device. The panel will search for all available and in range bluetooth devices.
3. Select the correct device from the list on the panel and ensure the pairing code matches that on your mobile device.
4. Touch “Pair” on the panel first, and then on your mobile device.
5. Your mobile device will now show under the “Paired Devices” list on the panel.

NOTE: Your phone may show the IQ Panel as “Not Connected”. This is normal

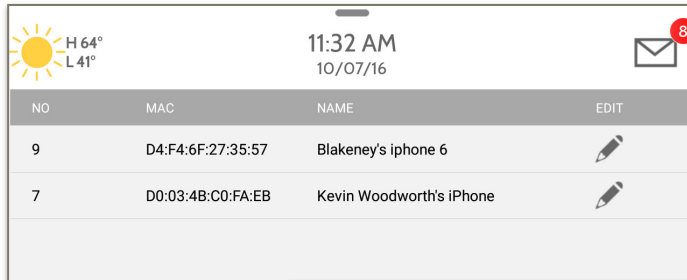
EDIT DEVICE



NO	MAC	NAME	EDIT
9	D4:F4:6F:27:35:57	Blakeney's iphone 6	
7	D0:03:4B:C0:FA:EB	Kevin Woodworth's iPhone	

1. Select the pencil next to the device you would like to edit.

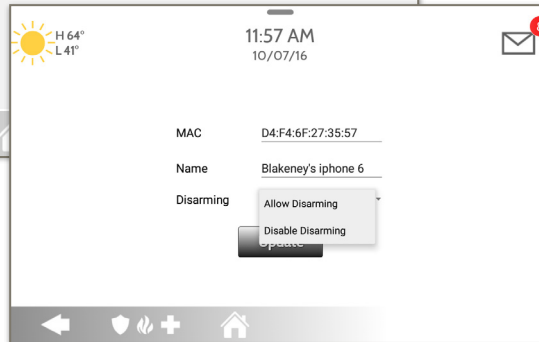

MAC D4:F4:6F:27:35:57

Name Blakeney's iphone 6

Disarming

2. Select whether or not you would like to allow a device to disarm the panel when in proximity.

DELETE DEVICE

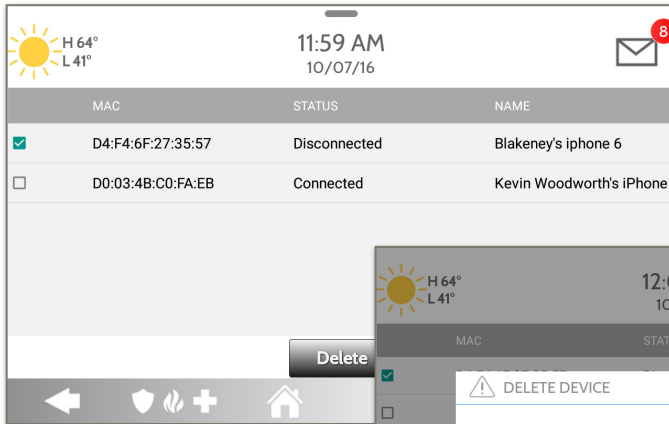

1. Select the check box next to the device you would like to delete.

2. Select "Delete" at the bottom of the page.

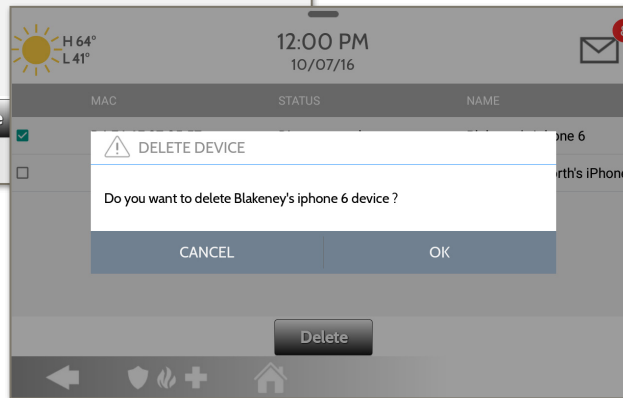

3. Select "OK" to confirm and delete the device.

REMOVE ALL DEVICES

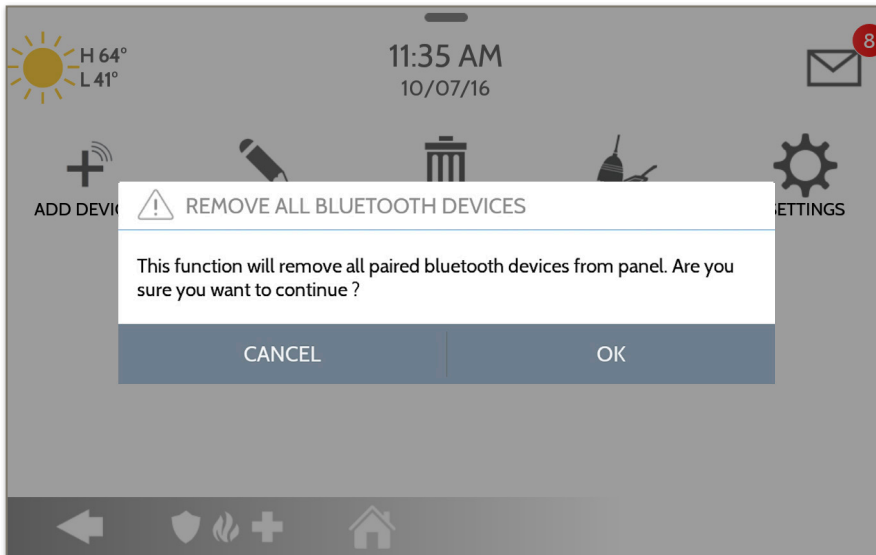

To delete and remove all enrolled Bluetooth devices at once, select “Remove All Devices”.

Next select “OK” to confirm you would like to delete.

SETTINGS

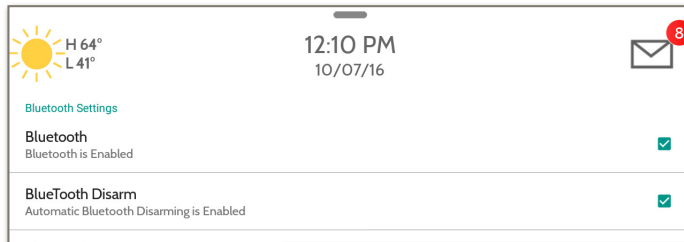

BLUETOOTH:

Select or un-select this box to enable or disable the bluetooth radio.

BLUETOOTH DISARM:

Select or un-select this box to enable or disable the ability to disarm the panel via Bluetooth. To change this on an individual level you must edit the specific device.

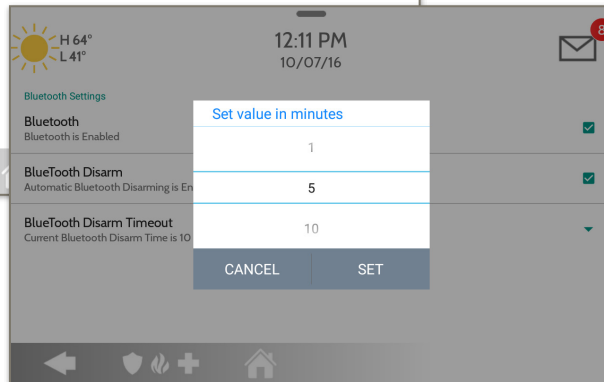

BLUETOOTH DISARM TIMEOUT:

Change the time in which the panel must wait after it's been armed to away before it allows a bluetooth device to disarm it. **Default 10 min**

Select from 1, 5, 10, 20 or 30 minute disarm timeout

ADD SPEAKER

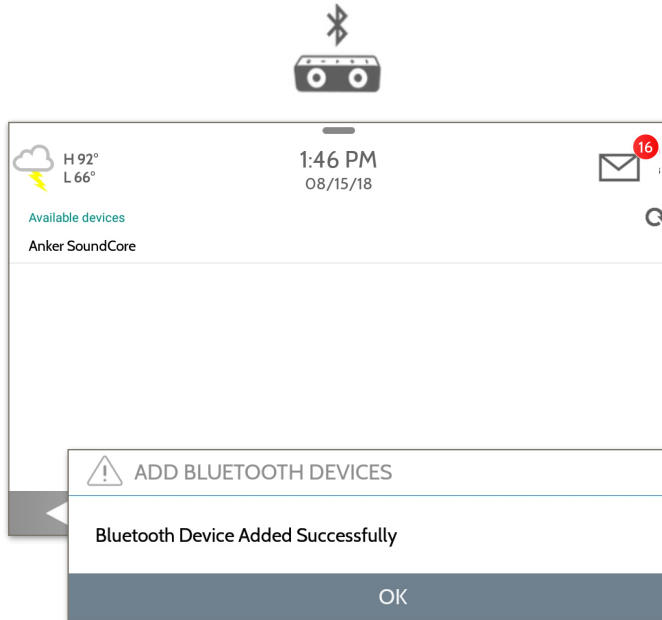

1. Select “Add Speaker”
2. Initiate Bluetooth pairing from the speaker.
3. Touch the correct device from the list on the panel to begin the pairing process.
4. Once paired, a pop up showing “Bluetooth Device Added Successfully” will appear. Touch “OK” to confirm.
5. Your speaker will now show under the “Paired Devices” list on the panel.

NOTE: Only “Anker” brand speakers are supported. Model a3102 is highly recommended.

SYSTEM TESTS

SYSTEM TESTS



System Tests

There are many different tests you can perform to ensure the system is working properly.



Wi-Fi Test

Test the panel's connection to the wireless (Wi-Fi) network



Sensor Test

Shows actual dBm signal strength of each sensor and graphs sensor events against the ambient noise floor of the environment



Cellular Test

Test the panel's connection to the cellular network and Alarm.com



Image Sensor Config

Test the panel's connection to Image Sensors



Z-Wave Tests

Test communication between devices and the panel. Rediscover network, counters, neighbor info, diagnostics & advanced diagnostics



PowerG Test*

Ping and receive signal strength from a PowerG sensor.

FIND IT

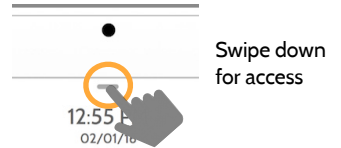

Swipe down for access



SETTINGS



ADVANCED SETTINGS



ENTER CODE (1111, 2222)



SYSTEM TESTS

* PowerG Test available only if a PowerG Daughter card is installed in the panel.

SYSTEM TESTS



Panel Glass Break Test

Test the panel's microphones to ensure proper sensitivity for built in Glass Break



Dual Path Test

Verifies the Wi-Fi path is connecting to Alarm.com



Daughter Cards Test

Tests the integrity of the installed daughter cards



Panel Test

Runs through a complete test of the panel's running processes

FIND IT

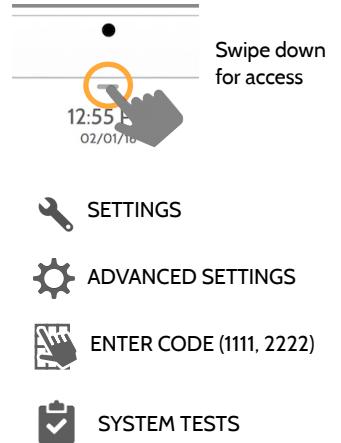

WI-FI TEST



Wi-Fi Test

The Wi-Fi test checks the IQ Panel 2's connection to your network (router). Before running this test, be sure to connect the panel to the network. See "customization" section for directions on connecting to Wi-Fi.

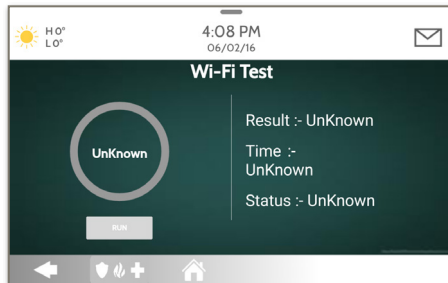

A successful test will result in a "pass" and indicates the date and time of the test along with connection speed.

To perform a Wi-Fi Test, touch the "Run" button.

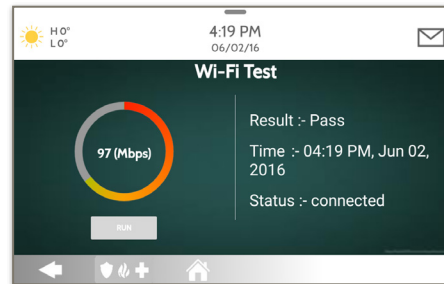

Note: If test fails, please check your Wi-Fi settings.

FIND IT

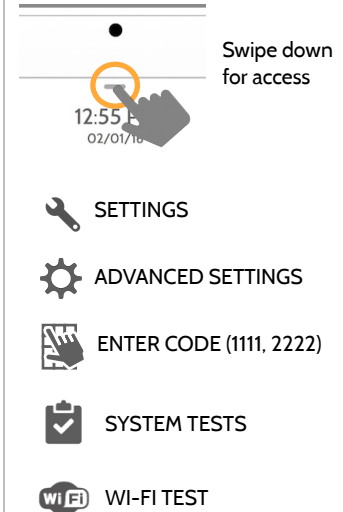



SENSOR TEST



Sensor Test

Shows actual dBm signal strength of each sensor and graphs sensor events against the ambient noise floor of the environment. Also displays the traditional packet count method. This new version of the Sensor Test requires **RF PIC Version 10.2.15-G1** or higher.

ZONE	NAME	AVERAGE DBM	LAST EVENT RESULTS (DBM) (PACKETS)		
1	Back Window	Strong (-43)	Strong (-47)	Perfect (16)	
2	Front Window	Strong (-31)	Strong (-33)	Perfect (8)	
3	Back Door	Good (-55)	Good (-55)	Excellent (7)	





Refer to page 99 for the sensor packet results table.

The Advanced Sensor Test shows a summary page of each sensor paired to the panel along with the average dBm level, the last event's dBm level and how many packets were received from the sensor.

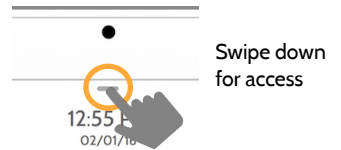
Select the graph icon to the right of each sensor to view an individual sensor's graphed signal strength in real time.

FIND IT



-  SETTINGS
-  ADVANCED SETTINGS
-  ENTER CODE (1111, 2222)
-  SYSTEM TESTS
-  SENSOR TEST

Note: For UL/cUL, perform a placement test first for all wireless initiating devices. The acceptable result shall be "Excellent".

SENSOR TEST



Noise Floor

From the Sensor Test page select the “Settings” cog to view the “Real Time Noise Floor”. The noise floor represents the dBm threshold at which the panel can no longer sense signals from sensors.

ZONE	NAME	AVERAGE DBM	LATEST RESULTS (DBM) (PACKETS)	Settings
1	Versa	Strong (-58)	Strong (-61)	Clear All Sensor Data Real Time Noise Floor
2	Flow	Strong (-62)	Strong (-67)	
4	Front Door	Strong (-51)	Strong (-59)	

Lower dBm levels mean there is less noise or interference on the sensor’s specific operating band or frequency.

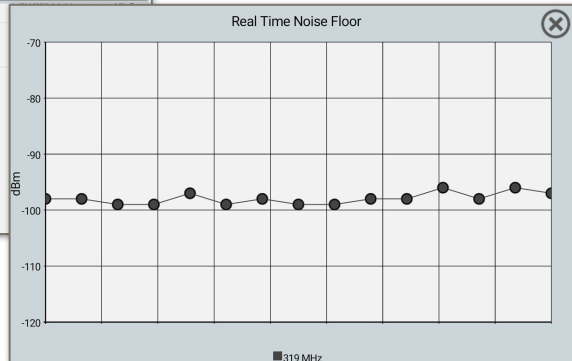

FIND IT

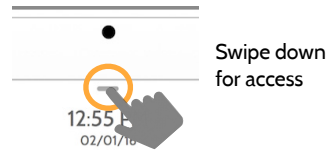

- SETTINGS
- ADVANCED SETTINGS
- ENTER CODE (1111, 2222)
- SYSTEM TESTS
- SENSOR TEST

Note: For UL/cUL , perform a placement test first for all wireless initiating devices. The acceptable result shall be “Excellent”.

SENSOR TEST

- Colored points on the graph represent each state change or supervisory signal transmitted from a sensor to the panel. Points are colored based on frequency.
- The **YELLOW** line represents a dBm level where signal strength is “Poor” and potential RF failures could occur. This line dynamically adjusts to 12 dBm above the ambient RF noise floor in the environment.
- The **RED** line represents a dBm level where signal strength is “Critical” and RF failures are likely. This line dynamically adjusts to 6 dBm above the ambient RF noise floor in the environment.

TROUBLESHOOTING:

If a sensor falls below the yellow line, try changing its orientation (vertical/horizontal), move the sensor to a different part of the door/window or adjust the panel’s RF pigtail antenna.

Then re-test to see if the result improved.

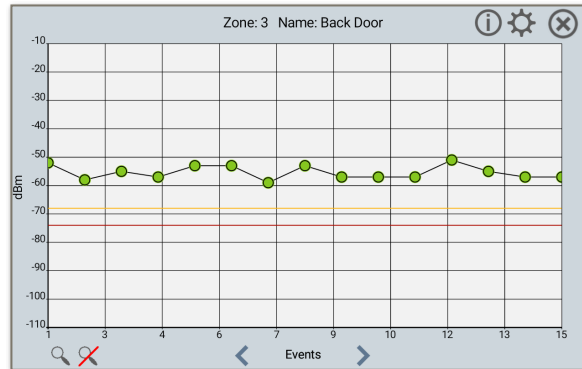

FIND IT

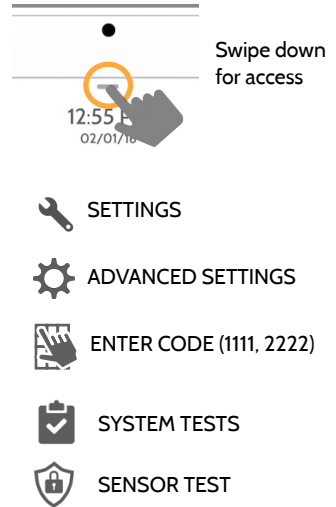

SENSOR TEST



Sensor Test

The panel can test its connection and communication to individual security sensors. Before running this test there must be at least one security sensor paired with the system. This version of the sensor test is for panels with the older **RF PIC Version 10.2.15-GO**.

Sensors connected to the panel will appear on the screen. The panel will detect open and close reports. **Please allow 10 secs between tests if tripping the same device more than once.** "Signal Source" relates to a sensor's frequency.

The panel will audibly report and display test results from "No Signal" to "Perfect", including how many packets were received.

NO	ID	SIGNAL SOURCE	NAME	RESULT	LAST RUN TIME
1	61B8A0	G	Water	No Signal	
2	625DA1	G	Front Door	Perfect (8)	04:49 PM, Jun 07, 2017

Results	Packets Received
Perfect	8
Excellent	6-7
Good	3-5
Minimum	1-2
No Signal	No RF packets received

FIND IT

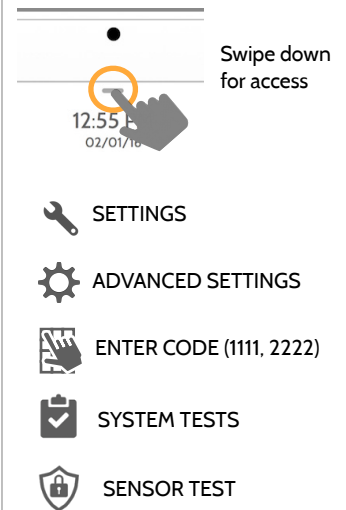

Note: For UL/cUL , perform a placement test first for all wireless initiating devices. The acceptable result shall be "Excellent".

CELLULAR TEST



Cellular Test

Test the panel's built-in cellular radio connection. You must first activate the radio through Alarm.com prior to running this test. Cell signal strength is only available after the test has been ran successfully.

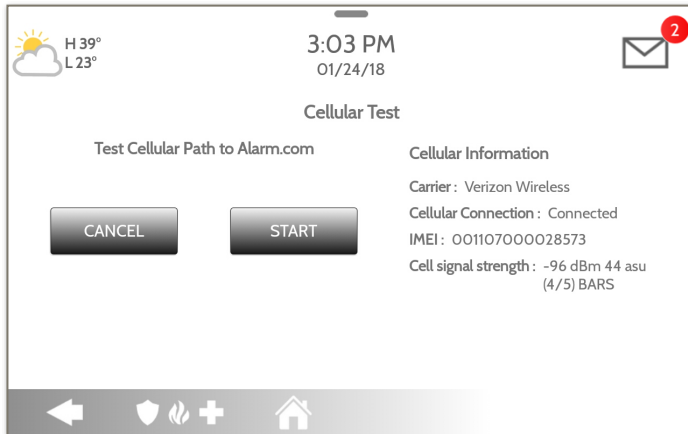

To begin the test press "Start" and watch for the results on the screen.

FIND IT

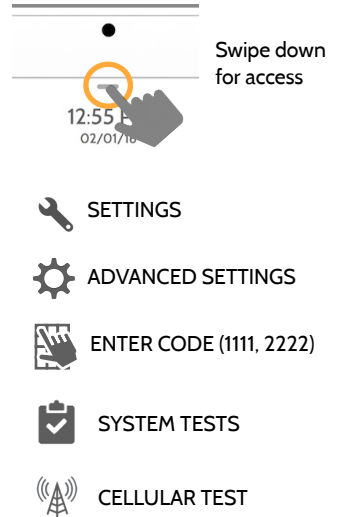

IMAGE SENSOR CONFIG



Image Sensor Config

Test an image sensors connectivity with the panel to ensure they are communicating properly and are able to take photos.

Choose an Image Sensor to Test:

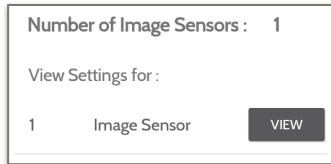

Select the desired Image Sensor by touching "View" next to its name



Touch "Sensor Tests"

Select the test you want to run:

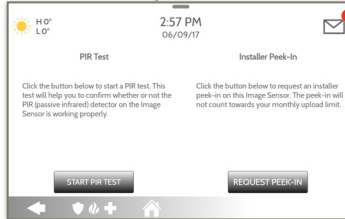

PIR Test checks the motion sensor

Installer Peek In tests the camera (Results appear through the Alarm.com app)

FIND IT

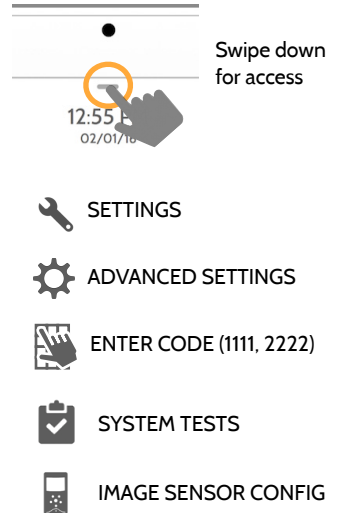

Z-WAVE TESTS



Z-Wave Test

Test the connection between the panel and enrolled Z-Wave devices to ensure they are communicating properly.

To perform a Z-Wave Test, touch the “Run” button. A successful test will result in a “Pass” and a time stamp.

ID	TYPE	STATUS	TEST TIME	RESULT
2	Light	Normal		Run
3	Light	Normal		Run
4	Door Lock	Unreachable		Run

Note: If a test fails, relocate device, change batteries and/or rediscover network.

FIND IT

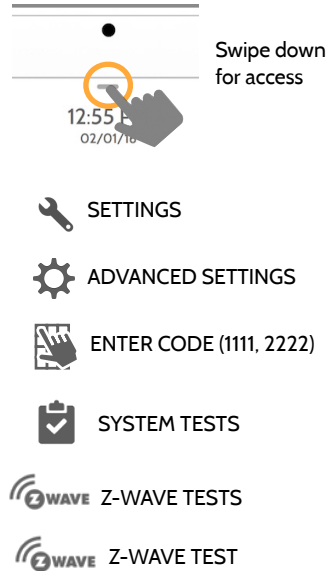

Z-WAVE TESTS



Rediscover Network

After installing or moving a Z-Wave device one should always “Rediscover the Network”. This re-maps the network and ensures all devices have the most efficient communication path leading back to the panel.

Select a single device or all and then select “Rediscover”. A result including a time stamp will appear under “Status”.

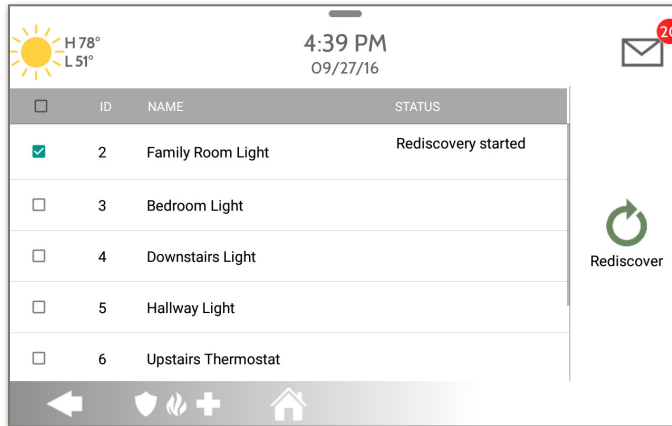

Note: If a test fails, relocate device, change batteries and/or rediscover network.

FIND IT

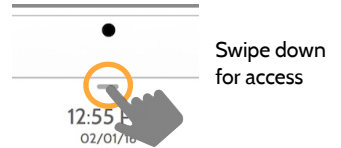

- SETTINGS
- ADVANCED SETTINGS
- ENTER CODE (1111, 2222)
- SYSTEM TESTS
- Z-WAVE Z-WAVE TESTS
- REDISCOVER NETWORK

Z-WAVE TESTS



Neighbor Info

Use “Neighbor Info” to view which devices can “see” each other. The more neighbors a device can see means more possible routes back to the controller.

ID	NAME	NEIGHBOR INFO
2	Light	View
3	Bedroom Light	View
4	Front Door	
5	Thermostat	

The screenshot shows a mobile app interface with a status bar at the top (6:44 PM, 06/03/16) and a notification icon. Below the title 'Neighbor Info' is a table with columns 'ID', 'NAME', and 'NEIGHBOR INFO'. The 'Light' device (ID 2) has a 'View' button circled in white, with an arrow pointing to a pop-up window.

Touch “View” next to any device and a pop-up will appear listing its “Neighbor Nodes”

Neighbor Nodes for Light (5)

4 : front_door

CLOSE

FIND IT

Swipe down for access

12:55 PM
02/01/16

- SETTINGS
- ADVANCED SETTINGS
- ENTER CODE (1111, 2222)
- SYSTEM TESTS
- Z-WAVE Z-WAVE TESTS**
- NEIGHBOR INFO

Z-WAVE TESTS

FIND IT



Counters

View a numerical representation of the Z-Wave network. View failed and acknowledged commands as a whole or from an individual device. A well designed network should have at least a 98% acknowledgment vs failed rate.

H 42°
 L 18°
 1:50 PM
 01/25/18

Acked commands no auto route : 0
 Acked commands auto route : 5434
 Failed commands no ack : 1
 Failed commands network failed : 0
 Failed commands network not idle : 0
 Failed commands network no route : 0

RESET ALL

ID	NAME	PASSED	FAILED	RESET COUNTERS
3	Light	2921	0	Reset
4	IO Outlet	2521	1	Reset

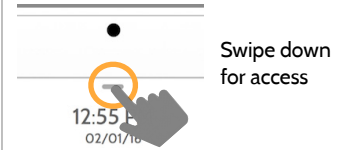

- SETTINGS
- ADVANCED SETTINGS
- ENTER CODE (1111, 2222)
- SYSTEM TESTS
- Z-WAVE Z-WAVE TESTS
- COUNTERS

Z-WAVE TESTS

COUNTER	DESCRIPTION
Acked commands no auto route	Command was successful and acknowledged by the sensor; it did not use the normal automatic Z-Wave network route to execute the command for this device (command was re-routed on the Z-Wave network in order to succeed)
Acked commands auto route	Command was successful and acknowledged by the sensor; it used the normal automatic Z-Wave network route to execute the command for this device.
Failed commands network failed	Not possible to transmit data because Z-Wave network is busy (jammed). Command failed to execute.
Network failed	Not possible to transmit data because Z-Wave network is busy (jammed). Command failed to execute
Network not idle	Auto-routed command failed because Z-Wave network is not yet stable. Command failed to execute.
Network no route	Auto-routed command failed because there is no successful Z-Wave network route to the device. Command failed to execute
Reset All	Resets all counters back to 0 as to better diagnose the network
Details	Shows individual device details such as passed and failed commands. Here you can also reset an individual device's counter

Z-WAVE TESTS



Z-Wave Diagnostics

View a graphical representation of the installed Z-Wave network. View the network's or an individual device's last known working route. Use the Key chart to decipher which devices are repeating nodes, have a strong or weaker signal or perhaps need to be moved to another location.

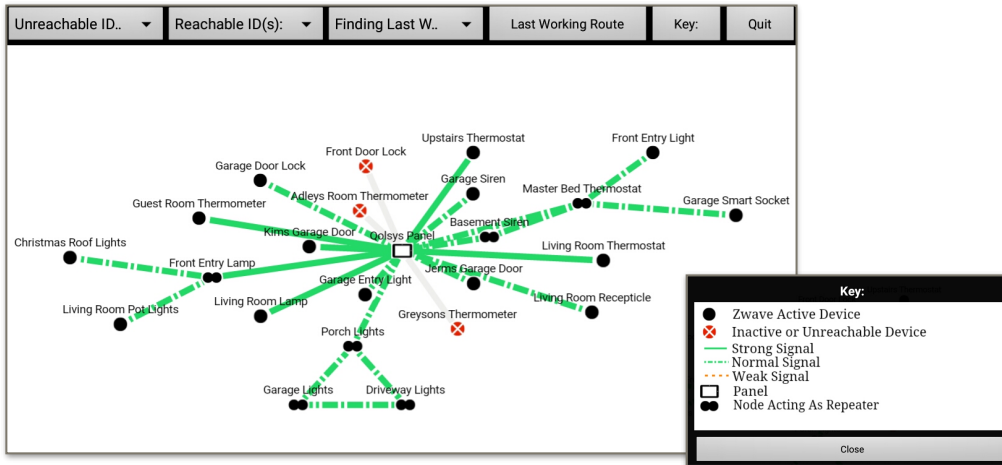

FIND IT

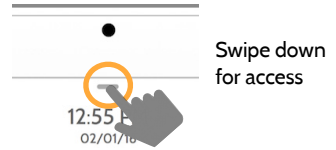

- SETTINGS
- ADVANCED SETTINGS
- ENTER CODE (1111, 2222)
- SYSTEM TESTS
- Z-WAVE Z-WAVE TESTS
- Z-WAVE DIAGNOSTICS

Z-WAVE TESTS



Advanced Z-Wave Diagnostics

Advanced Z-Wave diagnostics gives access to Network Health Test, Repeater Test & Last Working Route.

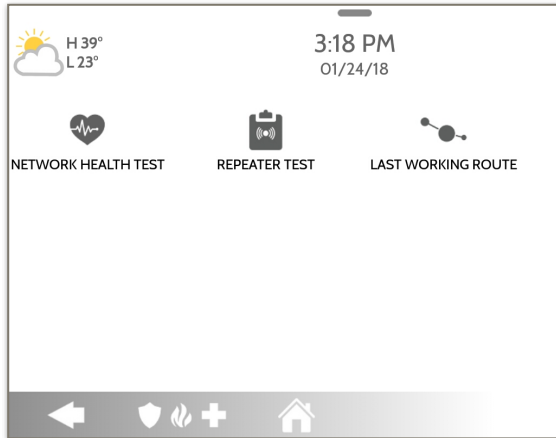

Network Health Test

Shows the minimum, maximum & average node response times on the network



Repeater Test

Tests the connection to dedicated Z-Wave repeaters on the network



Last Working Route

Shows the last working route for a specific node on the network. Also allows you to set a static “sticky” route

FIND IT

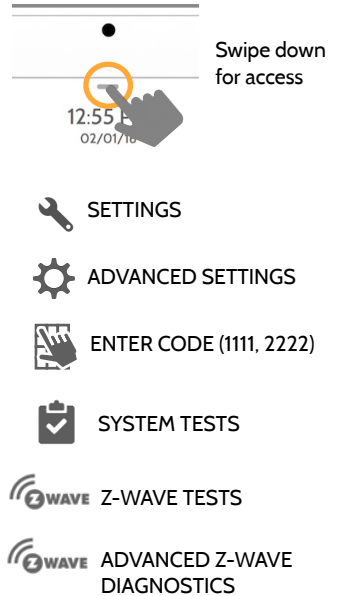

POWER G TEST



PowerG Test

Ping a PowerG sensor and receive back its signal strength. You can view the average signal strength over 24hrs as well as review the PowerG PIR CAM image.

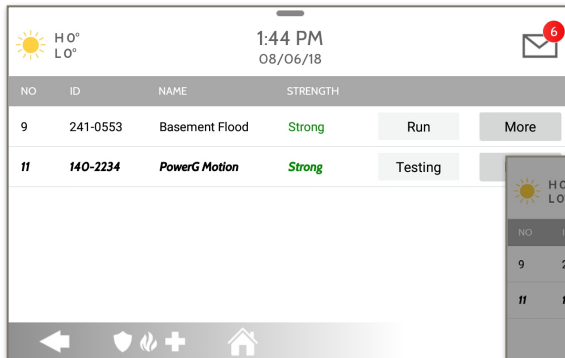

STRENGTH can be: Strong, Good, Poor or No Signal

FIND IT

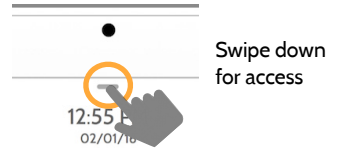

Swipe down for access



SETTINGS



ADVANCED SETTINGS



ENTER CODE (1111, 2222)



SYSTEM TESTS



POWERG TEST

*PowerG daughter card must be installed in the panel to access this test.

PANEL GLASS BREAK TEST



Panel Glass Break Test

Test the panel's microphones via a clap test or glass break test. This will ensure the built in detector and microphones are functioning properly when needed. Panel Glass Break must be enabled under Installer Settings to access this test.

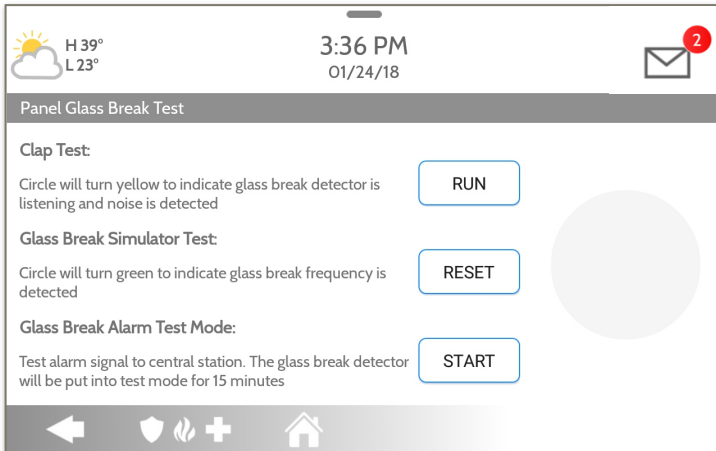

Testing

Select "Run" to begin test. Circle will turn **YELLOW** when a successful clap test has been detected and Microphones are listening.

Circle will turn **GREEN** when the panel hears the proper glass break frequency being detected.

FIND IT

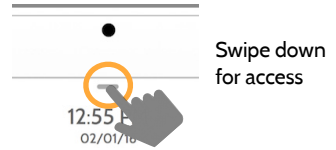

- SETTINGS
- ADVANCED SETTINGS
- ENTER CODE (1111, 2222)
- SYSTEM TESTS
- PANEL GLASS BREAK TEST

PANEL GLASS BREAK TEST



Glass Break Alarm Test Mode

Selecting “Start” will enable a 15 min test mode that allows the panel glass break detector to be tripped using a glass break simulator. Once tripped an alarm will be sent to the central station. Follow the on screen instructions to ensure a proper test.

RUN

RESET

START

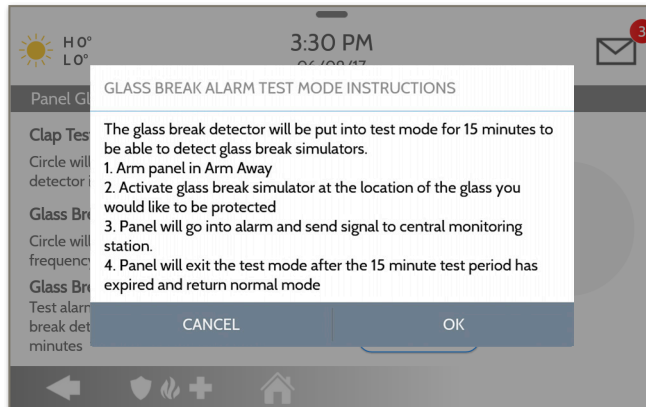

FIND IT

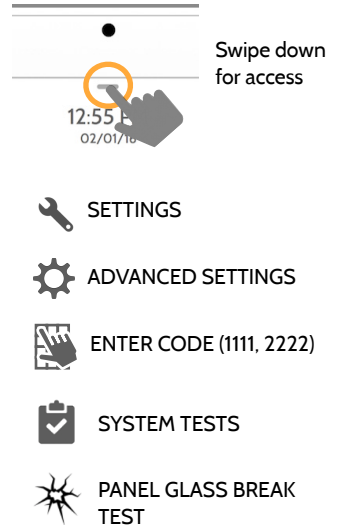

PANEL GLASS BREAK DETECTION REQUIREMENTS

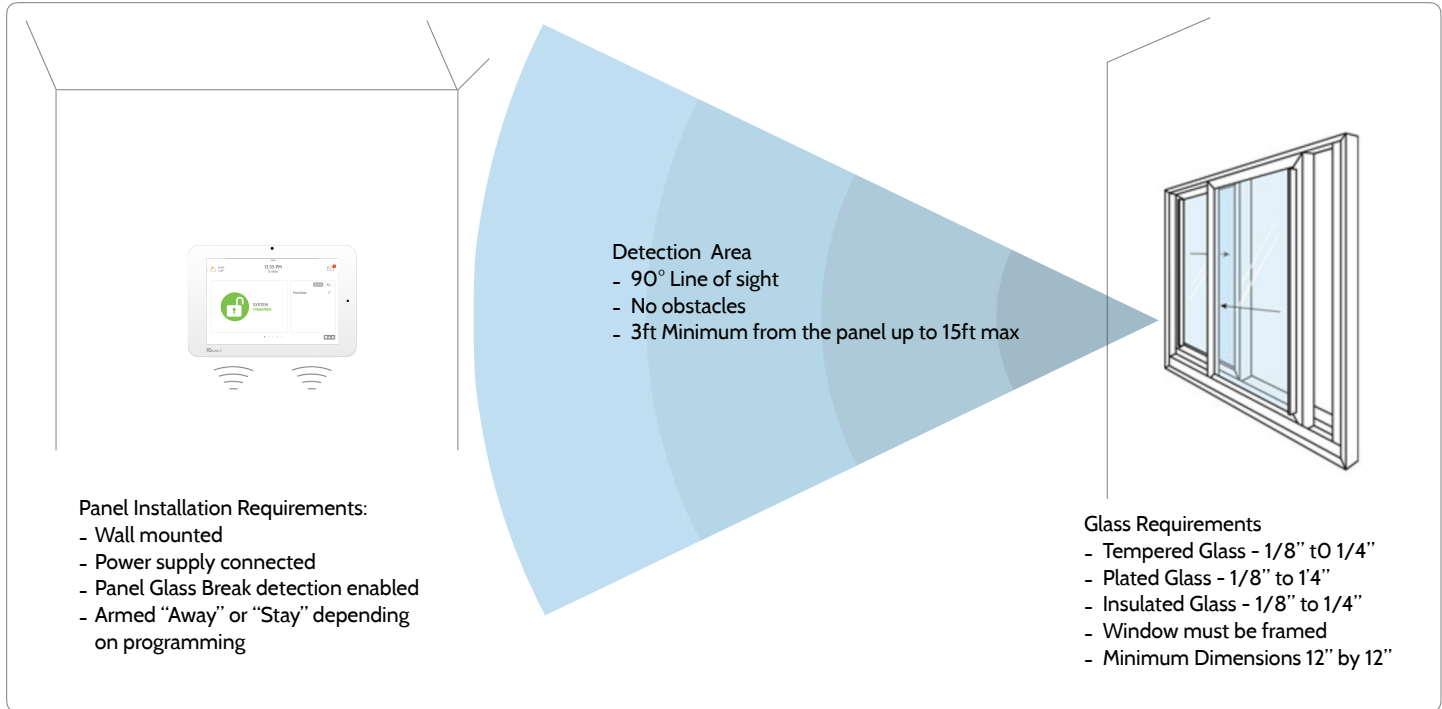

DUAL PATH TEST



When enabled, dual path connectivity allows the IQ Panel 2 to use both cellular and Wi-Fi radios for signals and communication simultaneously.

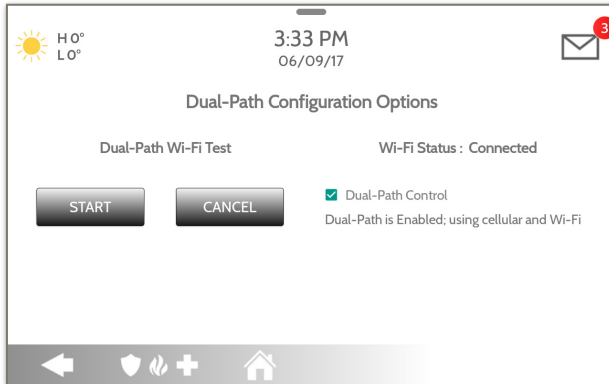

By default Dual-Path Control is enabled. To disable, “un-check” the box.

You can also run a Dual-Path Wi-Fi test to ensure that the Dual Path is connecting properly. Unlike the standard Wi-Fi test (which checks connection to the router) the panel will check the broadband connection to Alarm.com.

**Note: The IQ Panel 2 must be connected to a wi-fi network to enable Dual Path*

**IQ Panel 2 is compatible with the following UL/ULC listed monitoring station receivers: SG-System I/II/III/IV/5.
NOTE: Wi-Fi is for supplemental use only for UL/cUL**

FIND IT

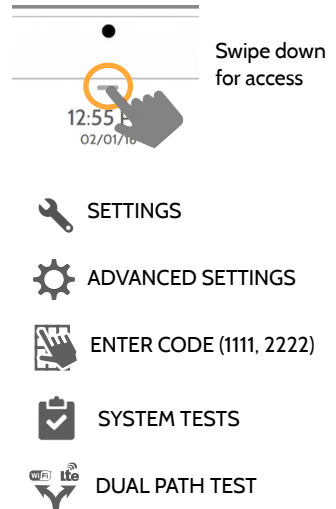

DAUGHTER CARDS TEST



Daughter Cards Test

Tests the integrity of installed daughter cards . Slots not populated will be “greyed” out and inaccessible to test.

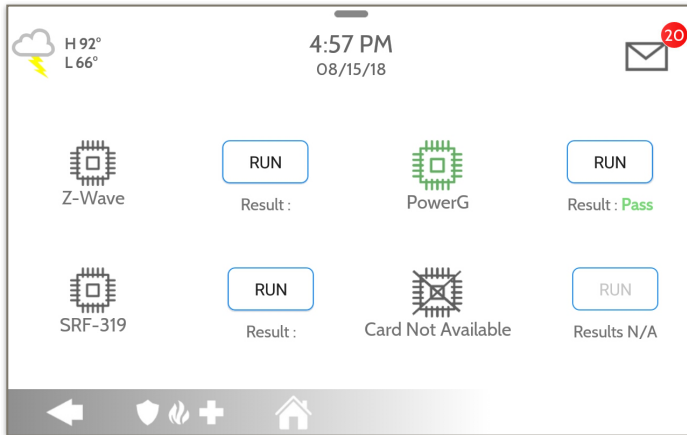

Select “Run” on an individual available card to start the test. In some cases the test may take several minutes after which the panel will show a result of a “Pass” or “Fail”.

If the test results in “Fail” double check the daughter card connection, reboot the panel and rerun the test again.

FIND IT

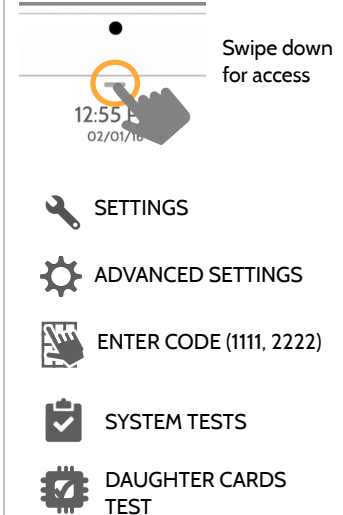

PANEL TEST



Panel Test

Runs through and tests all panel processes either all at once or one at a time.

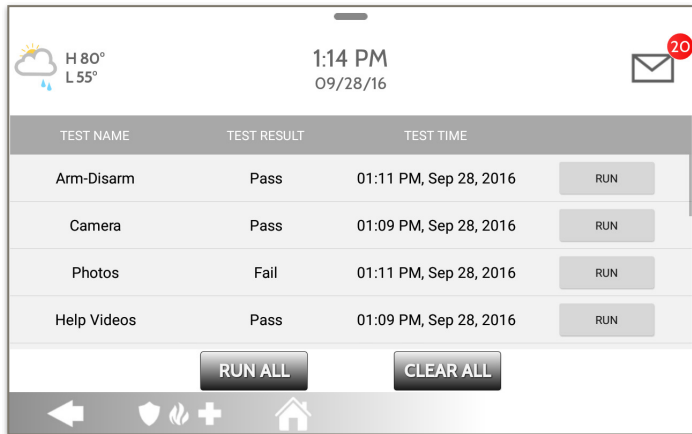

Select "Run" to perform an individual test or "Run All" to perform a test of all processes.

Running all tests at once will sound the siren.

FIND IT

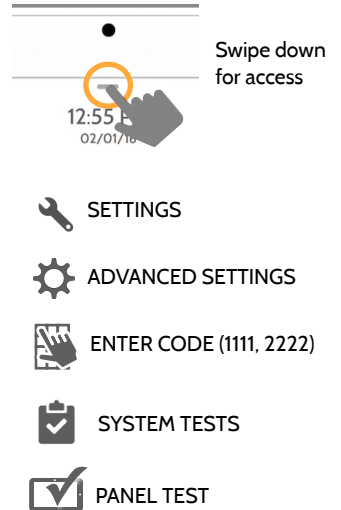

CUSTOMIZATION

USER MANAGEMENT



The IQ Panel 2 can hold up to 242 user codes. Only Dealer, Installer and Master user codes can create or edit user codes. Once a code is created, all information can be edited, except for the “User Type”.

User Type	Access Level	Partition Access
Dealer	All settings as well as Master Reset and access to change Dealer Contact information	All Partitions
Installer	All Settings	All Partitions
Master	All user-related features and Settings, including connecting to Wi-Fi, User Management, Sound App and Sensor customization	All Partitions
User	Arming/Disarming	A user may only access their assigned partition
Guest	Arming/Disarming	A user may only access their assigned partition
Duress	Disarming (but sends duress signal to security provider).	Partition 1 only

FIND IT

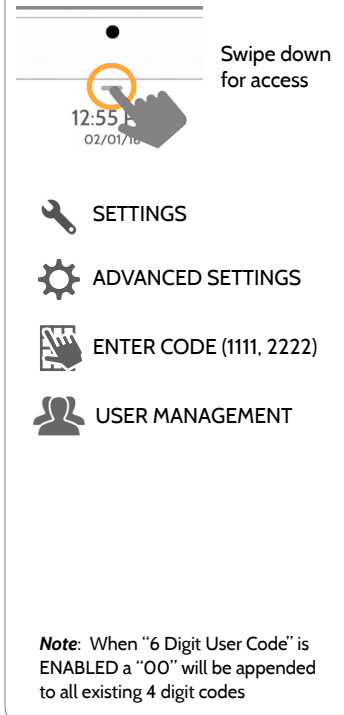

Swipe down for access

- SETTINGS
- ADVANCED SETTINGS
- ENTER CODE (1111, 2222)
- USER MANAGEMENT

Note: When “6 Digit User Code” is ENABLED a “00” will be appended to all existing 4 digit codes

DEALER BRANDING*



Dealer Branding

Here you can customize the Dealer Contact info, Logo, Help Videos and Billboard for any branding needs.



Contact Info

Edit Dealer Name, Email, Phone #, Zip Code, Website and Tag lines



Load Help Videos

Replace or add help videos to assist with end user troubleshooting



Load Custom Logo

Add your company's logo to the panel replacing the envelope.



Dealer Branding Settings

Enable/Disable On-Screen Billboard photo lock feature



On-Screen Billboard

Add advertising images to the photo frame which cannot be deleted by a user.

FIND IT

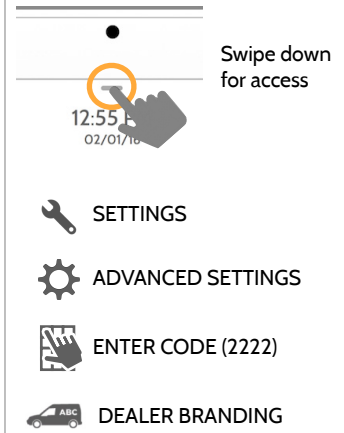

*This page available only through the Dealer Code

DEALER BRANDING*

FIND IT



Contact Info

Customize your contact info and determine what you'd like to be displayed in "Contact Us", located on the right side of the "Home Screen" header. Dealer Contact fields allow up to 25 characters, Tag Line 2 allows up to 50.

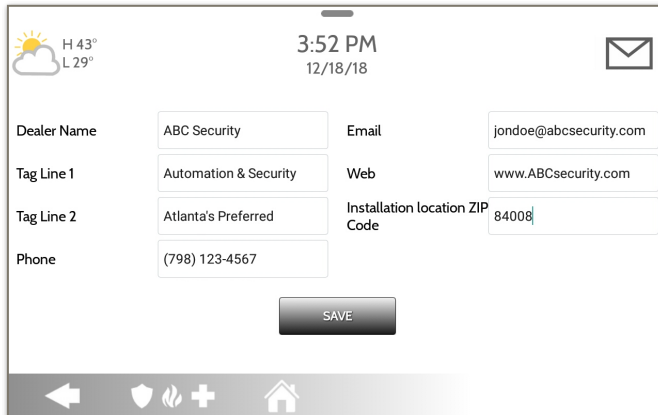

The screenshot shows a mobile app interface for editing contact information. At the top, it displays weather (H 43° L 29°), time (3:52 PM), and date (12/18/18). Below this is a form with the following fields:

Dealer Name	ABC Security	Email	jondoe@abcsecurity.com
Tag Line 1	Automation & Security	Web	www.ABCsecurity.com
Tag Line 2	Atlanta's Preferred	Installation location ZIP Code	84008
Phone	(798) 123-4567		



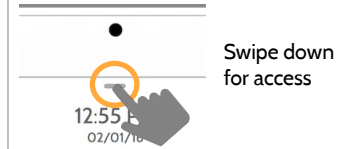

A "SAVE" button is located at the bottom of the form. The bottom of the screen shows a navigation bar with icons for back, shield, plus, and home.

Example:

ABC Security
Automation & Security
Atlanta's Preferred
798-123-4567
jondoe@abcsecurity.com
ABCSecurity.com
84008



Swipe down for access

-  SETTINGS
-  ADVANCED SETTINGS
-  ENTER CODE (2222)
-  DEALER BRANDING
-  CONTACT INFO

*This page available only through the Dealer Code

DEALER BRANDING*



Load Custom Logo

Load a custom dealer logo on to the Panel via micro SD Card. This image will replace the “envelope” icon in the upper right hand corner of the display.

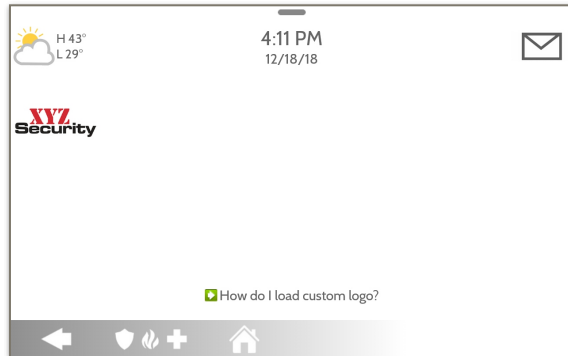

NOTE: Before removing the SD Card, go to “Settings” then touch “SD Card” and select “Unmount”

Load Custom Logo Steps:

1. Load logo* onto an SD Card
2. Insert the SD Card into the panel
3. Go to the Dealer Branding section on the panel
4. Touch “Load Custom Logo”
5. Touch the thumbnail of the logo you wish to load
6. Touch OK

Logo requirements:

- Saved in folder entitled “logo”
- 200 x 100 pixels (or less)
- JPEG or PNG

FIND IT

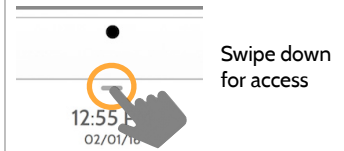

SETTINGS



ADVANCED SETTINGS



ENTER CODE (2222)



DEALER BRANDING



LOAD CUSTOM LOGO

*This page available only through the Dealer Code

DEALER BRANDING*



On-Screen Billboard

Load and lock up to 4 full-screen Dealer photos via micro SD Card as part of the photo frame screensaver. Dealer photos cannot be deleted by an end user.

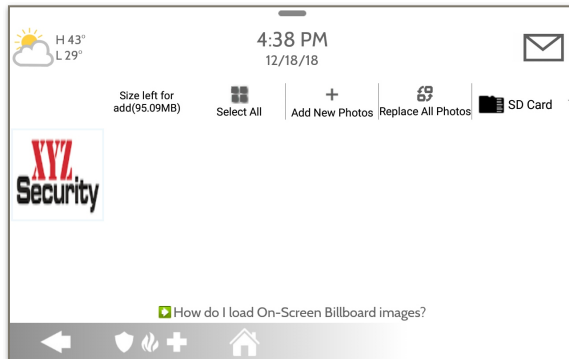

NOTE: Before removing the SD Card, go to “Settings” then touch “SD Card” and select “Unmount”

Load On-Screen Billboard Photos:

1. Load photos* onto an SD Card
2. Insert the SD Card into the panel
3. Go to the Dealer Branding section on the panel
4. Touch “On-Screen Billboard”
5. Touch the thumbnails of the photos you wish to load
6. Then choose “Add New” or “Replace All”



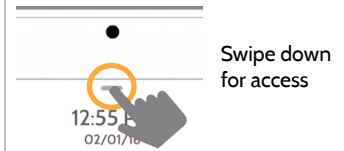

Photo requirements:

- Saved in folder entitled “billboard”
- 1280 x 800 pixels (or less)
- JPEG or PNG

FIND IT



Swipe down for access

-  SETTINGS
-  ADVANCED SETTINGS
-  ENTER CODE (2222)
-  DEALER BRANDING
-  ON-SCREEN BILLBOARD

*This page available only through the Dealer Code

DEALER BRANDING*

FIND IT



Load Help Videos

Upload custom help videos with an SD Card. Make your own troubleshooting videos for your customers or use our built-in videos.

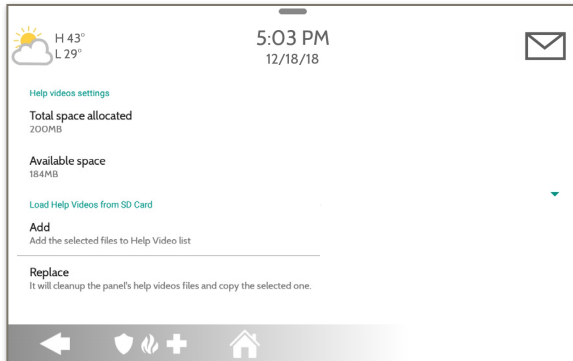

Load Help Videos:

1. Load videos* onto an SD Card
2. Insert the SD Card into the panel
3. Go to the Dealer Branding section on the panel
4. Touch “Load Help Videos”
5. Then choose “Add” or “Replace”



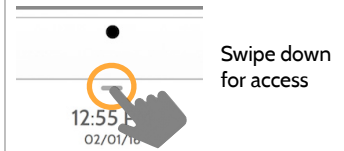

Video requirements:

- Saved in folder entitled “videos”
- Aspect ratio: 1280 x 800
- File Type: .m4v
- Total Storage Space: 200MB

NOTE: Before removing the SD Card, go to “Settings” then touch “SD Card” and select “Unmount”



Swipe down for access

-  SETTINGS
-  ADVANCED SETTINGS
-  ENTER CODE (2222)
-  DEALER BRANDING
-  LOAD HELP VIDEOS

*This page available only through the Dealer Code

CONNECTING TO WI-FI



To connect to a Wi-Fi network, follow the steps below:

Swipe down from the top menu bar and select settings.



Touch Advanced Settings (Installer Code)



Then touch “Wi-Fi”



Enable Wi-Fi if not already active

Available networks appear in a list. Touch the desired network and use the keyboard to type the password (if required)

Activate WIFI



Qolsys-5G
Connected



Now Communications



Qolsys



Sunset Room



Vertical Ops 2.4

+ Add wi-fi network

FIND IT

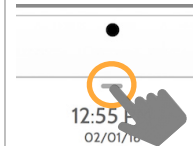

Swipe down
for access



SETTINGS



ADVANCED SETTINGS



ENTER CODE (1111, 2222)



WI-FI

WEATHER



H 36° L 20°

TODAY'S FORECAST

Today's forecast is displayed on the weather icon with a graphical representation of precipitation and High and Low temps.

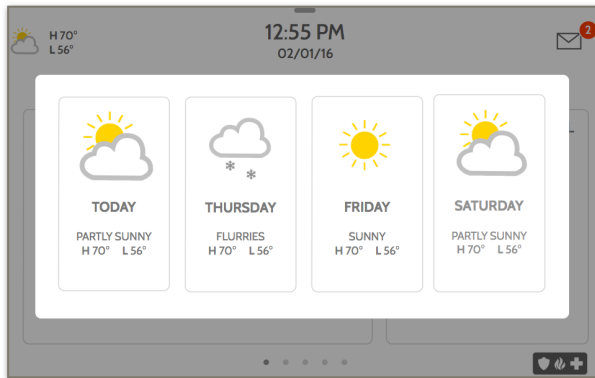

4-DAY FORECAST

Touch the weather icon to get a 4-day forecast. This information is updated once daily via Alarm.com services. (Will not display or update weather connected to wifi only)

LOCATION

Weather reporting is based on location as indicated by the zip code entered into Alarm.com when the account is created.

FIND IT

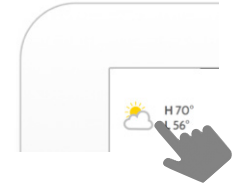

Touch the weather icon in the upper left corner of the header to reveal a 4 day forecast

PHOTO FRAME



PHOTO FRAME

The IQ Panel 2 can be set to display digital photos when not in use. This feature, called “Photo Frame”, can be changed or turned off through “Photo Frame Settings”. (Swipe down from the menu bar).

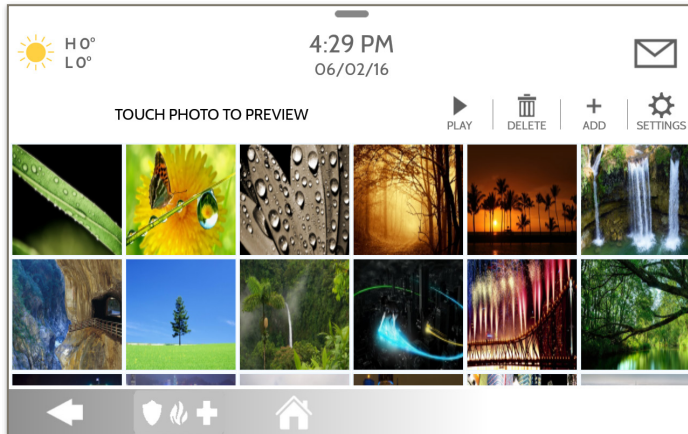

SETTINGS

Display type
Choose a display type for your photo frame. Opt to turn it off completely, scroll through pre loaded images or view a “weather clock”

FIND IT

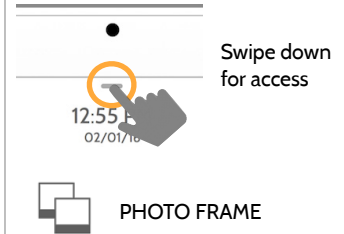

PHOTO FRAME APP BUTTONS



PLAY: Starts Photo Frame immediately. Good for testing photo frame feature appearance and transitions



REMOVE PHOTOS: Allows you to remove photos one by one or all at once



ADD PHOTOS: Add new photos using an SD card or download one of several “Wi-Fi” photo sets using your panel’s WiFi connection



SETTINGS: Change the Photo Frame’s “Display Type” from Off to On or enable a “Weather Clock” screen saver. Change transitions, adjust display time, set automatic on/off times and more

FIND IT

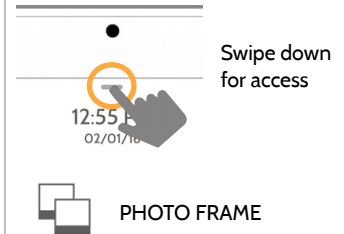
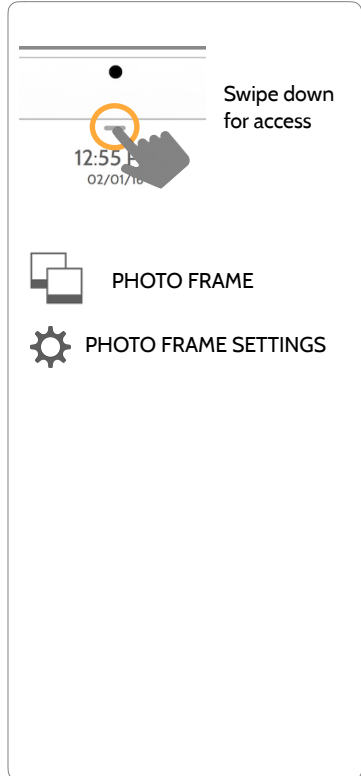

PHOTO FRAME SETTINGS

FIND IT

Item	Default	Description
Duration	1 minute	How long each image will show before transitioning to the next image in the library (1, 2, or 5 minutes)
Effect	Dissolve	Transition effect used between each image (fade to black, dissolve)
Shuffle	Enabled	Display pictures in random or sequential order
Display Type	Photo Frame	Choose what to display on the screen when the panel is not in use. (Off, Photo Frame and Weather Clock)
Photo Frame Start Time	10 minutes	Choose the amount of time to wait after the last touch before starting the selected display type. (5, 10, 15, 20, 25, or 30 minutes)
Nighttime Mode Start Time	11:00 PM	Determines the time when the display, voices or chimes shutdown completely. (Use this feature to turn off the LCD, voices and/or chimes at night)
Nighttime Mode End Time	6:00 AM	Determines the time when the display, voices or chimes "wake up" after sleeping. (Use this feature to turn the LCD, voices and/or chimes back on in the morning)
Nighttime Mode Settings	Display	Choose what the Nighttime Mode Start/End times have the ability to control (Display, Voices and/or Chimes)



LOAD IMAGES FROM SD CARD

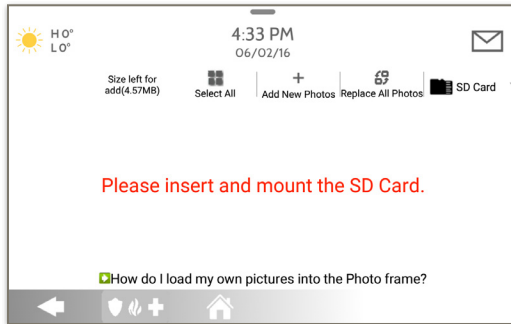

Card will slide all the way in.
To remove, push gently and card will spring out.

To load new images from an SD card:

- 1- Load photos* onto an SD Card
- 2- Insert the SD Card into the panel
- 3- Open the “Photo Frame” app
- 4- Press “Add Photos”
- 5- Choose “Replace All Photos” or “Add New Photos”
- 6- Wait for the images to load
- 7- Once loaded, you can press “Play” to test.

NOTE: Before removing the SD Card, go to “Settings” then touch “SD Card” and select “Unmount”

FIND IT

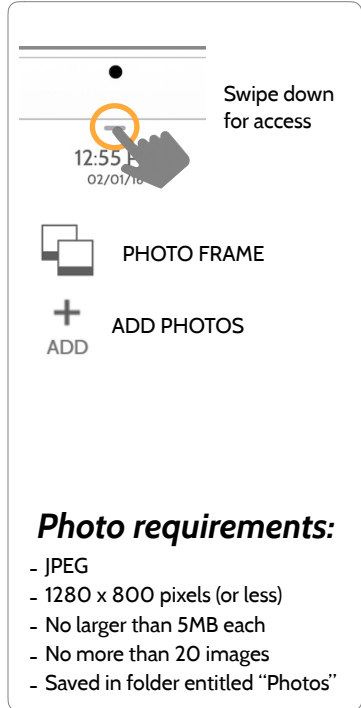

MAINTENANCE

UPGRADE SOFTWARE

FIND IT



Upgrade Software

Upgrade the panel's software version using Wifi or an SD Card.

Setting	Description
Upgrade Using Network	Search the network for updates and install new software <i>Note: for UL/cUL, remote software uploading is not allowed</i>
Upgrade Using SD Card	Search an inserted SD Card for updates and install new software
Downgrade Using Network	With the proper Patch Tag the system can be properly downgraded
Patch Tag	A code corresponding to a specific software update on the server
Automatic Upgrade	Allow the panel to update its software as new versions become available <i>Note: For UL/cUL, automatic upgrade is not allowed</i>
Automatic Background Check and Download	Allows the panel to check for new software in the background and download it to local storage so that it can be applied at a later date. Default Enabled
Automatic Check Interval	Determines interval the IQ Panel 2 will look for software update. Available options are Every Night, Once a Week, Once a Month. Default Every Night

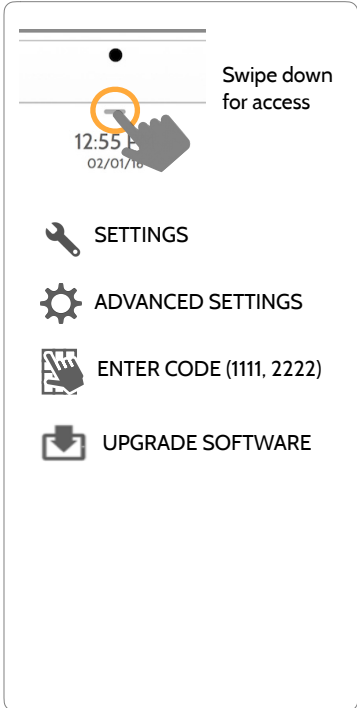

Note: Proper maintenance requires prompt administration of any software updates

UPGRADE SOFTWARE USING WI-FI

Keeping your panel up to date is essential in ensuring it receives the newest features and is free from bugs.

To perform a software update using Wi-Fi follow the steps below:



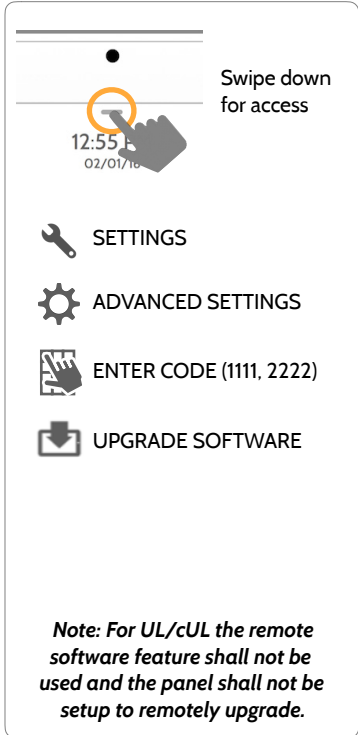

- 1- Ensure your panel is connected to Wi-Fi and has an internet connection.
- 2- From the drop down menu select "Settings" then "Advanced Settings". (Installer/Dealer Code)
- 3- Touch "Upgrade Software"
- 4- Touch "Upgrade Using Network" The IQ Panel 2 will check for the latest software update. If your panel is up to date you will see a message confirming that you have the most recent software version.
- 5- If a software update IS available the panel will automatically begin downloading it.
- 6- Once the download is complete a pop up message will appear informing you that in order to install the software you must restart the panel. Touch "OK." Your panel will install the update and automatically restart.

FIND IT



Swipe down for access

12:55
02/01/16

-  SETTINGS
-  ADVANCED SETTINGS
-  ENTER CODE (1111, 2222)
-  UPGRADE SOFTWARE

Note: For UL/cUL the remote software feature shall not be used and the panel shall not be setup to remotely upgrade.

SOFTWARE UPDATES VIA SD CARD

- 1- Insert an SD card into your computer. (**We recommend a class 4 or higher SDHC card with 4gb - 16gb storage space*)
- 2- Download the current software from dealers.qolsys.com (*requires login*)
- 3- Once the file is downloaded, right click the file and select "Unzip" or "Open"
- 4- Drag all files to your SD card. Delete ANY other files, and safely remove the SD card from your computer
- 5- Slide your SD card into the slot on the upper right side of the IQ Panel 2.
- 6- From the drop down menu Touch "Settings"
- 7- "Advanced Settings" and enter a valid Installer code (*default is 1111*)
- 8- Touch "Upgrade Software"
- 9- Touch "Upgrade using SD Card"
- 10- The panel will search the SD Card for the patch and begin downloading it automatically.
- 11- Once complete touch "OK" to reboot the panel. **DO NOT TOUCH THE SCREEN.** The process will take about 5 minutes and the LED may turn red, screen may turn off, etc. After the panel reboots the home screen will appear and the LED will turn green. For the next 5 minutes the panel will update the backup partition. Do not power down or use the panel during this time
- 11- Eject the SD Card: ("Settings" then touch "SD Card" then "Unmount SD Card"

IMPORTANT: Failure to perform these steps in the proper sequence may result in data corruption and/or panel failure.

FIND IT

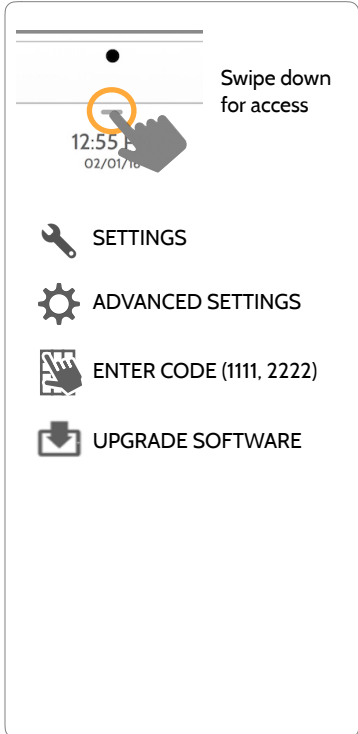

AUTOMATIC SOFTWARE UPDATES

Turning on automatic software updates enables the panel to check for new software version Every Night by default.

From the drop down menu select "Settings"

"Advanced Settings": (Installer/Dealer Code)

Touch "Upgrade Software"

Make sure the "Automatic Updates" button is checked.

Change update interval by selecting "Automatic Upgrade Interval"



QUESTIONS? Contact us at techsupport@qolsys.com

FIND IT

Swipe down for access

- SETTINGS
- ADVANCED SETTINGS
- ENTER CODE (1111, 2222)
- UPGRADE SOFTWARE

Note: For UL/cUL the automatic software update feature shall not be enabled.

BATTERY REPLACEMENT

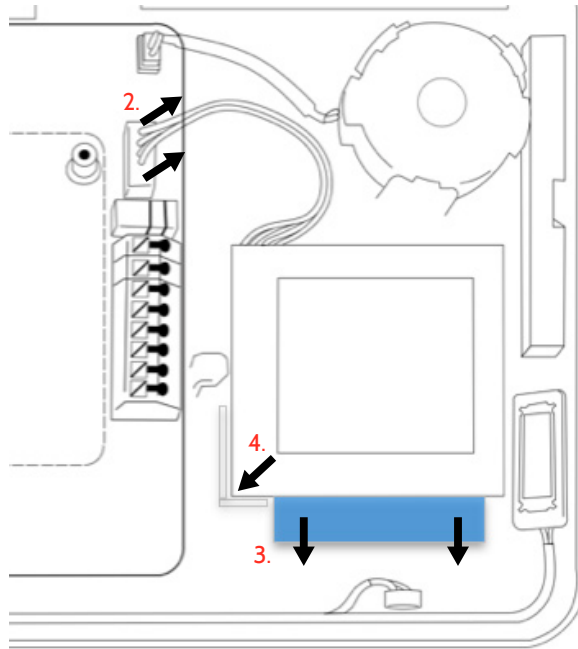

1. **Power down panel:** Go to Advanced Settings and enter the Installer/Dealer/Master code, then select “Power Down”
2. **Unplug Battery Connector:** Once the panel is powered down, unplug 4 pin battery connector from the board.
3. **Remove Battery:** Pull the blue tab from under the battery downwards. This will peel away the tape holding the battery in place.
4. **Install New Battery:** Remove the protective film from the adhesive tape on the back of the battery and seat the battery into the bottom lefthand plastic corner. Plug the battery connector back into the board.

CAUTION:

Do **NOT** use a screwdriver or anything sharp that could puncture the battery.

Do **NOT** pull on the battery cable to try and remove battery.

TROUBLESHOOTING

ABOUT

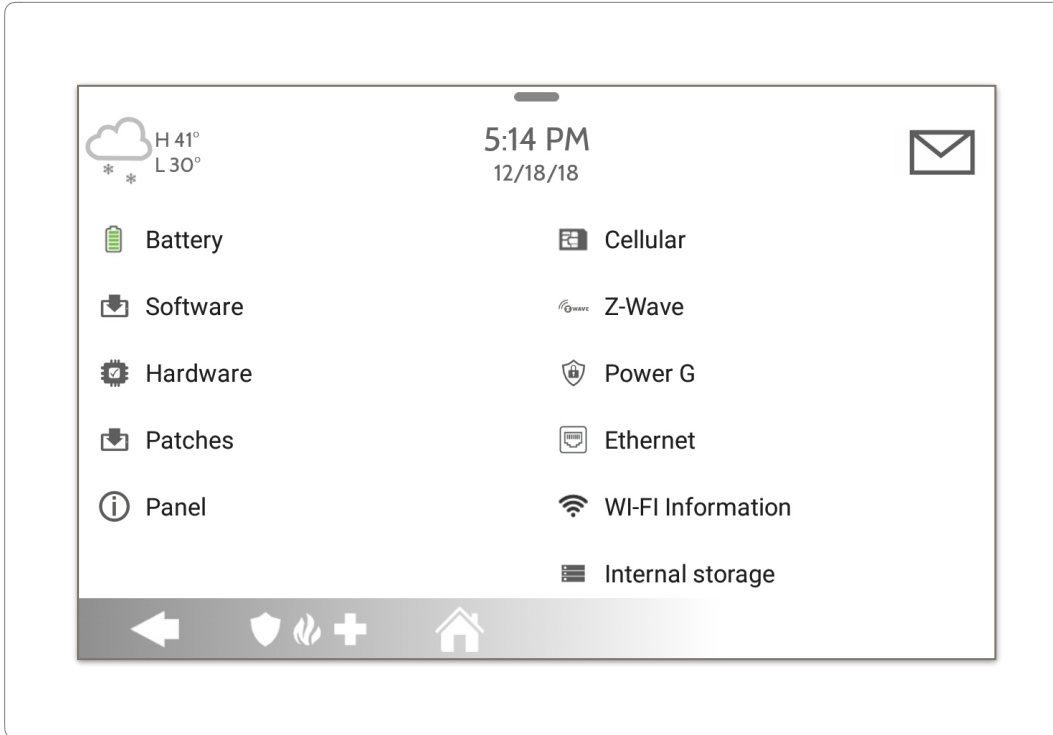

FIND IT

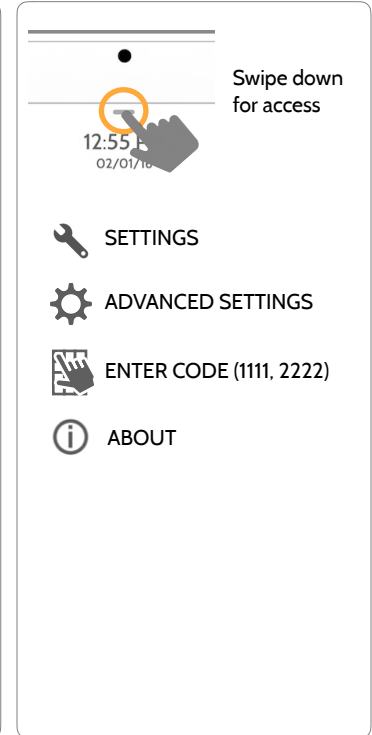

ABOUT

Item	Description	
Battery	Battery Status: Disconnected, Charging, Full	Battery Level: Displayed in %
Software	Software Version: Current Software Version Build Number:	Linux Version: Android Version:
Hardware	Hardware Version: Manufacturer: Qolsys Inc. San Jose, CA PCA Serial #: Part #: System Configuration:	System Serial #: RF PIC Version: EEPROM Format Version: Image Sensor Version:
Patches	Patch Description: Details of all previous patches applied	Last Upgrade Date:
Panel	MAC Address:	Panel Up Time:
Cellular	Carrier: Current Carrier Cellular Connection: no signal, registered etc.. Cellular Signal Strength: x/6 bars, (xx/xx) internal IMEI: alarm.com radio number	IMSI: Carrier Sim Information ICCID: Carrier Sim Information Baseband Version: Configuration Version:

ABOUT

Item	Description	
Z-Wave	Home ID: Z-Wave Firmware Version: Z-Wave API Version:	Manufacturing ID: Product Type: Product ID:
PowerG	Modem Firmware Version Modem Build Number Radio Firmware Version	Radio Software ID PowerG RF Band
Ethernet	Connection: Connected/Disconnected IP Address: Panel's IP Address when connected	Internet: Can the panel communicate outside the home. Available/Unavailable
Wi-Fi Information	Connection: Connected/Disconnected IP Address: Panel's IP Address when connected SSID: Network panel is connected to	Speed: Connection speed shown in Mbps Internet: Can the panel communicate outside the home. Available/Unavailable
Internal Storage	Total Space: Total space shown in GB Available Space: Space available for media Photos: Breakdown of space used for photos	Videos: Breakdown of space used for videos Logs: Space used for storing panel logs

POWER DOWN

DO NOT remove all power without following the steps below. In the event of needing to move the panel from one location to another it is safe to unplug the power supply while leaving the battery plugged in.

1. From the drop down menu select “Settings”.
2. Select “Advanced Settings” then enter your installer code
3. Select “Power Down”
4. Wait for panel LED to turn off
5. Disconnect the power

IMPORTANT: Failure to perform these steps in the proper sequence may result in data corruption and/or panel failure.



QUESTIONS? Contact us at techsupport@qolsys.com

FIND IT

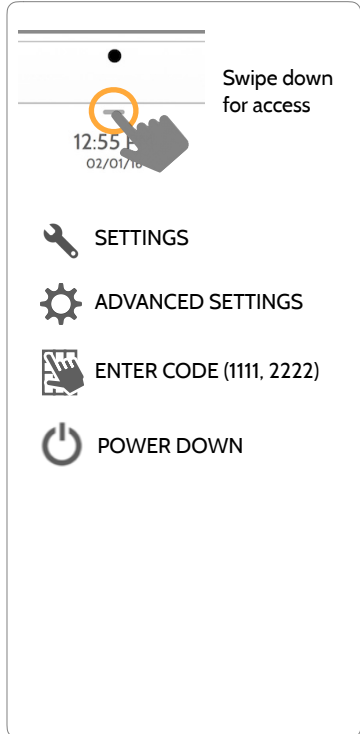

PANEL REBOOT

If the panel is experiencing difficulties you can often resolve it by resetting the operating system.

1. From the drop down menu select “Settings”.
2. Select “Advanced Settings” then enter your installer code
3. Select “Panel Reboot”
4. Wait for the panel to restart

IMPORTANT: Failure to follow these steps properly may result in data corruption and/or panel failure.



QUESTIONS? Contact us at techsupport@qolsys.com

FIND IT

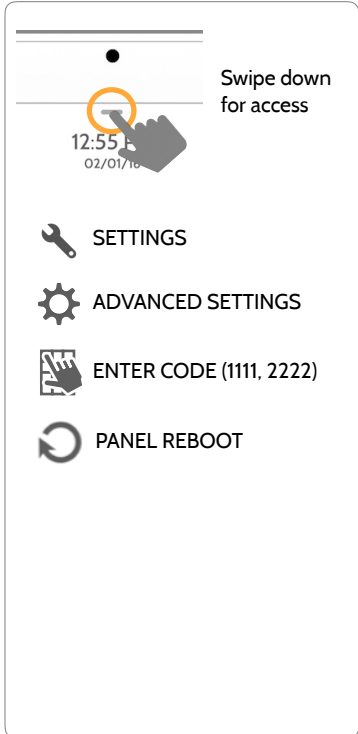

HARD REBOOT

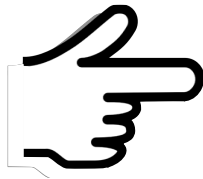

x 30 sec

IMPORTANT: Performing a hard reset may result in data corruption and/or panel failure. Only use this when absolutely necessary.



QUESTIONS? Contact us at techsupport@qolsys.com

PANEL TEST TROUBLESHOOTING

If you run a panel test and it fails, use the following steps to fix the issue.

Test	Description	If fails:
Arm-Disarm	Tests the arm/disarm operation	Reboot panel, run test again then if necessary perform a master reset and repeat test
Camera	Tests panel camera operation	Reboot panel, run test again then if necessary perform a master reset and repeat test
Photos	Checks that photos are loaded in the photo frame app	<ol style="list-style-type: none"> 1) Go to Settings -> Photo Frame -> Add Photos 2) Add photos from Wifi photo sets or an SD card
Help Videos	Checks help videos are installed in the panel.	<ol style="list-style-type: none"> 1) Go to Settings/Advanced Settings/Installation -> Load Help Videos 2) Load All the Help videos in SD card and insert it into panel 3) Add the selected files from SD card to help videos list on the panel
Battery	Checks panel battery health	<ol style="list-style-type: none"> 1) Make sure the battery is connected 2) If test continues to fail, replace the battery
LED Green/Red	Check panel LED operation	<ol style="list-style-type: none"> 1) Reboot the panel and run the test again 2) Master reset and repeat test

PANEL TEST TROUBLESHOOTING

Test	Description	If fails:
Panel Tamper	Check panel Tamper state	<ol style="list-style-type: none"> 1) Check to ensure backplate is secure and installed properly. 2) Repeat test.
AC Status	Check panel AC power status	<ol style="list-style-type: none"> 1) Inspect the wire leads are secure and properly connected on the terminal block and adapter. 2) Repeat test.
Internet Connection	Check panel's Internet connectivity	<ol style="list-style-type: none"> 1) Go to Wifi Setting page, Enable Wifi and connect to a Wifi Network 2) Make sure Internet is available on the home router. You can check internet information in the "About" section. 3) Contact your network service provider on continued internet connectivity failure.
Wi-Fi	Tests whether panel is connected to Wifi network	<ol style="list-style-type: none"> 1) Go to Wifi Setting page and enable wifi. 2) Connect to a Wifi Network
Upgrade Service	Checks that the panel can receive updates from the Qolsys servers	<ol style="list-style-type: none"> 1) Verify internet and Wi-Fi connections.
Z-Wave	Check panel's Z-Wave module operation	<ol style="list-style-type: none"> 1) Reboot the panel and repeat test. 2) Master reset and repeat test
Sirens	Check that the panel's siren is functioning properly (Burglar, Auxiliary, Fire & CO).	<ol style="list-style-type: none"> 1) Verify the siren is plugged in

CANNOT LOAD HELP VIDEOS

If your panel cannot load a help video you will receive an error message. Please ensure that your video(s) meet the requirements:

Acceptable File types:

.m4v

Total storage space:

200MB

NOTE: videos look best

in aspect ratio

1280 x 800

LEGAL

IMPORTANT

Important warning and information can be found on the interior and exterior of the panel's mounting plate.

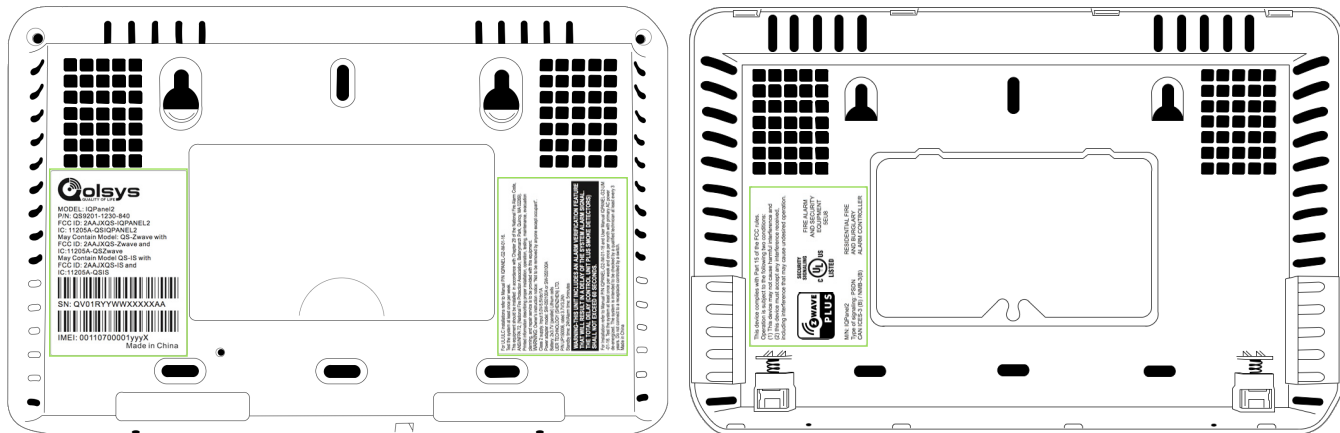

IMPORTANT

This Class [B] digital apparatus meets all requirements of the Canadian Interference–Causing Equipment Regulations.

Cet appareil numérique de la classe [B] respecte toutes les exigences du Règlement sur le matériel brouilleur du Canada.

IMPORTANT! Changes or modifications not expressly approved by Qolsys Inc. could void the user's authority to operate the equipment.

CAUTION! This equipment complies with radiation exposure limits set forth for uncontrolled environment. The antenna(s) used for this transmitters must be installed to provide a separation distance of at least 20 cm from all persons and must not be collocated or operating in conjunction with any other antenna or transmitter. This device complies with Part 15 of the FCC Rules. Operation is subject to the following two conditions: (1) this device may not cause harmful interference, and (2) this device must accept any interference received, including interference that may cause undesired operation.

IMPORTANT

This equipment has been tested and found to comply with the limits for a Class B digital device, pursuant to part 15 of the FCC Rules. These limits are designed to provide reasonable protection against harmful interference in a residential installation. This equipment generates, uses and can radiate radio frequency energy and, if not installed and used in accordance with the instructions, may cause harmful interference to radio communications. However, there is no guarantee that interference will not occur in a particular installation. If this equipment does cause harmful interference to radio or television reception, which can be determined by turning the equipment off and on, the user is encouraged to try to correct the interference by one or more of the following measures:

- Reorient or relocate the receiving antenna.
- Increase the separation between the equipment and receiver.
- Connect the equipment into an outlet on a circuit different from that to which the receiver is connected.
- Consult the dealer or an experienced radio/TV technician for help.

SPECIFICATIONS

SPECIFICATIONS



Items	Parameters	IQ Panel 2
Platform	Android OS	Android 5.1
LCD Display	Size	7" LCD
	Resolution	1280 x 800
	Brightness	300 cd/m2
	RGB	24bit
Touchscreen	Type	Capacitive glass multi-touch
User Codes	Up to 242	Role based (Dealer, Installer, Master, User, Guest, Duress)
Wireless	WiFi	Wi-Fi 802.11 a/b/g/n/ac dual band 2.4/5ghz - including built-in router capability
	Image Sensor	Supports up to 5 Alarm.com Image Sensors (if included)
	Z-Wave	Supports up to 152 devices (80 lights, 15 Smart Sockets, 20 Locks, 10 Thermostats, 21 Misc, 6 Garage Doors)
	Cellular	LTE (Bands 2,4,5,12,13,17)
	Security R/F	Up to 128 RF Zones. IQ Panel 2 uses Encrypted 319.5MHz. IQ Panel 2+ uses PowerG plus ONE of the following depending on SKU: Encrypted 319.5MHz, 345MHz or 433MHz.
	Bluetooth	Qualcomm Bluetooth Low Energy (BLE) 4.0
Hardwire Input	Wired x2	2 non powered closed loop circuit with 4.7k EOL resistor
Siren Output	Wired x1	1 controlled output (open collector), 300mA max with a 12v power supply wired in series
Flash Memory	Internal Storage	12GB NAND Flash
SD Card Slot	Push-Push	Micro SD slot x 1
LED Indicator	Status LED	Green (Disarmed), Red (Armed)

SPECIFICATIONS



Items	Parameters	IQ Panel 2
Speaker	Stereo 1W x 2	Stereo speakers (unified audio)
Camera	Front Camera	5MP fixed focus
Microphone	Microphone	Stereo microphones x 2
Siren	Piezo	SPL minimum 85dB for UL985
Tamper	Tamper Switch	Reporting tamper release button
Battery	Type	Litium Polymer 3200mAh
Buttons	Standby	Right side button used for sleep/wake, hard reboot, and clean screen cancel
Mechanical	Dimension	5"H x 7.75"W x .75"D (195mm x 130mm x 23mm)
Power Supply	AC/DC	Output: 5v - 7v 1000mA CC, Input 100-240VAC 50/60Hz
Mount	Back Plate	Wall mount or table top (stand included)
Certification	UL/cUL	UL-985, UL-1023, UL-1635, UL-639, UL-498A, UL-634, ULC-634, ULC-S306, CSA-C22.2
	FCC	2AAJXQS-IQPANEL2 (may contain additional modules with separate FCC ID's)
	IC	11205A-QSIQPANEL2
	Safety	
Temperature	Operational	-10-50C, Note: not evaluated by UL/cUL
	Storage	-40 - 80C

SUPPORTED S-LINE SENSORS



Detector Type	Model
Door/Window	QS1133-840 ^{UL} , QS1135-840, QS1136-840, QS1137-840
Door/Window - Shock Sensor	QS1138-840
Vanishing Door/Window Contact	QS1134-840 ^{UL}
PIR Motion Detector	QS1230-840 ^{UL} , QS1231-840
Glassbreak Detector	QS1431-840 ^{UL}
Smoke Detector	QS5110-840 ^{UL}
Wireless CO Detector	QS5210-840
Keyfobs	QS1331-840
Tilt Sensor	QS1131-840
Flood Detector	QS5536-840
Temperature Sensor	QS5535-840
Hardwire Translator	QS7130-840, QS7131-840

^{UL} indicates that the device is certified to UL standards

SUPPORTED POWER-G SENSORS



Detector Type	Model
Door/Window	PG9945
Door/Window - Shock Sensor	PG9935
Vanishing Door/Window Contact	PG9975
PIR Motion Detector	PG9904(P), PG9914, PG9934(P), PG9924
Dual Tech (PIR+Microwave) Motion Detector	PG9984(P)
Outdoor Motion Detector	PG9974(P), PG9944, PG9994(P)
Glassbreak Detector	PG9922
Smoke Detector	PG9916, PG9926, PG9936
Wireless CO Detector	PG9913
Keyfobs	PG9929, PG9939, PG9949, PG9938
Sirens	PG9901, PG9911
Wireless Repeater	PG9920



IQ Panel 2

QS9201-1200-840

QS9202-1200-840

IQ Panel 2+

Verizon

AT&T

Telus

QS9201-1208-840 QS9202-1208-840 QS9207-1208-124

QS9201-5208-840 QS9202-5208-840 QS9207-5208-124

QS9201-4208-840 QS9202-4208-840 QS9207-4208-124

Conforms to UL Std. S985, 1023. & 1635

Certified to ULC Sub C1023 & ULC Std S545

Qolsys Inc. proprietary.

Reproduction without permission is not permitted.

Document#: IQP2-IM-12-18

Revision Date: 12/17/18

Software version: 2.3.0